

HILTI

POS 15/18

Operating instructions

en

Mode d'emploi

fr

Manual de instrucciones

es

Manual de instruções

pt

1

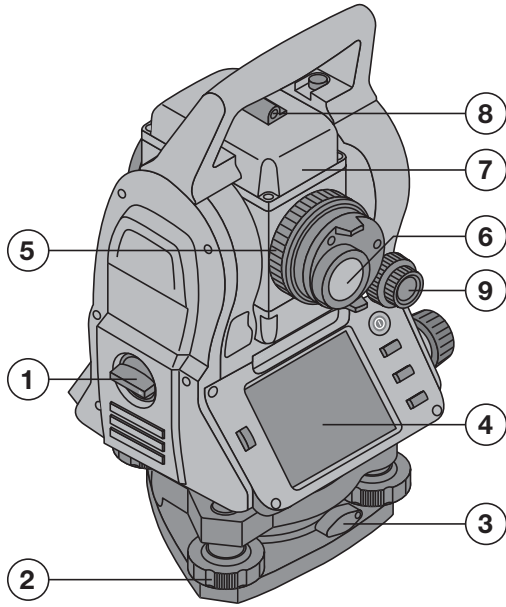

2

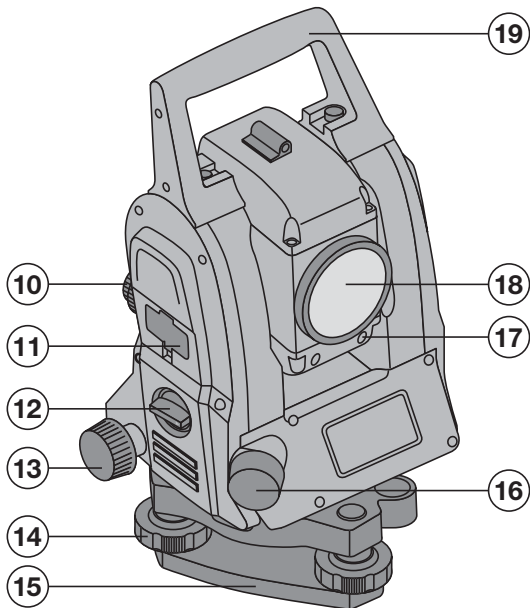

3

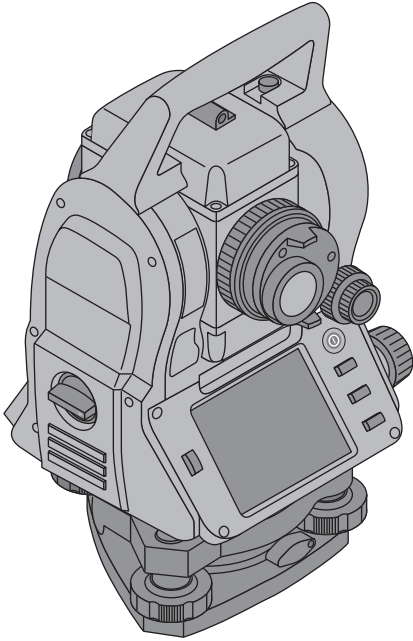

4

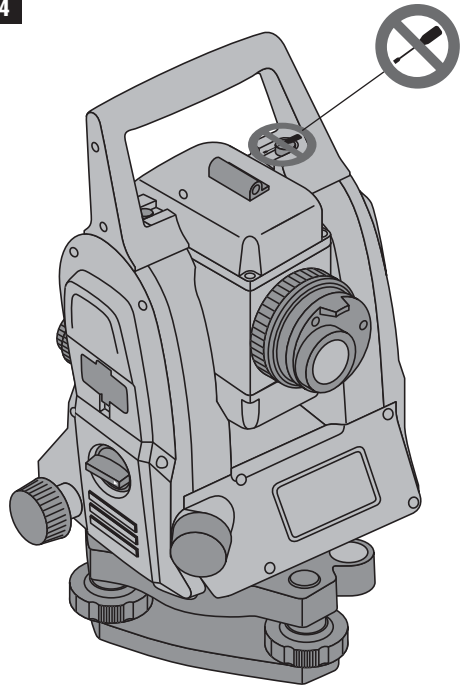

5

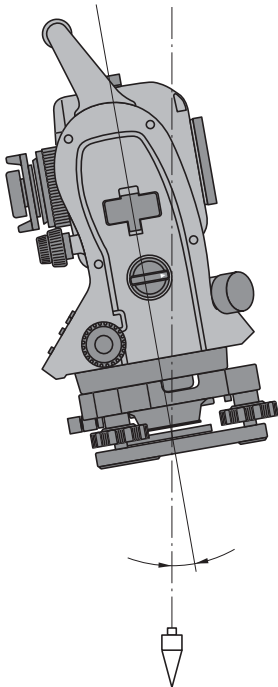

6

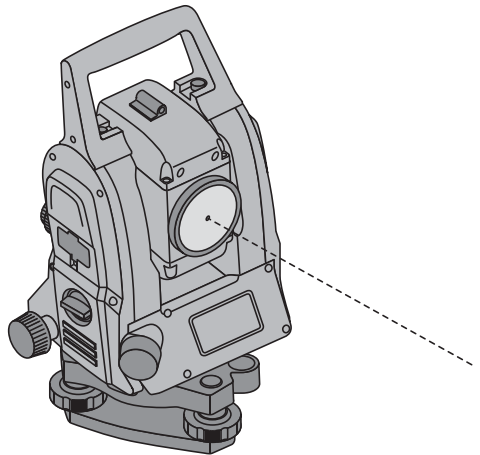

7

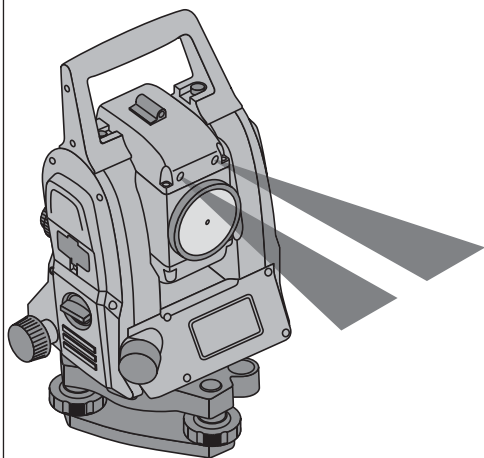

8

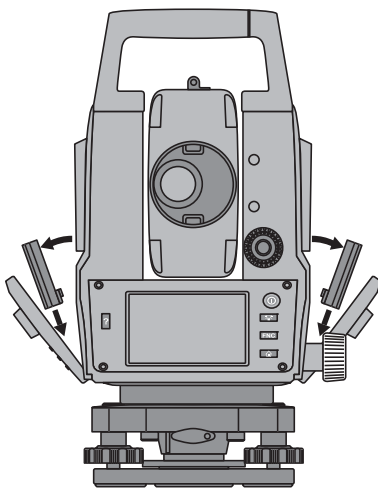

9

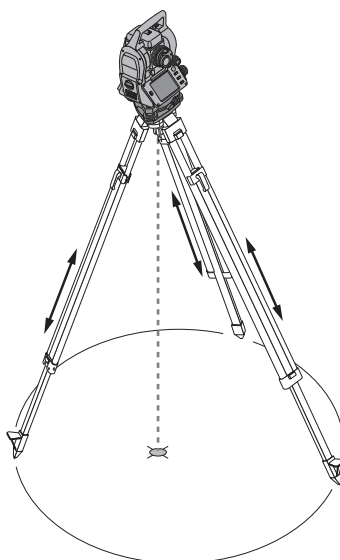
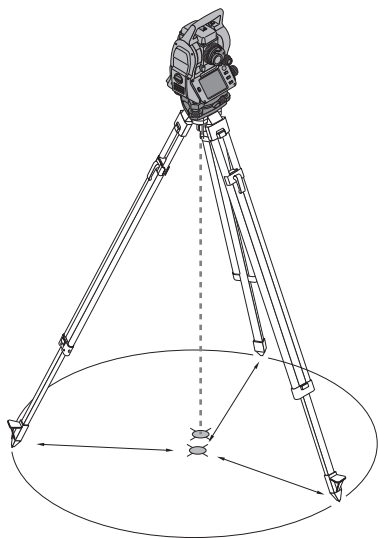

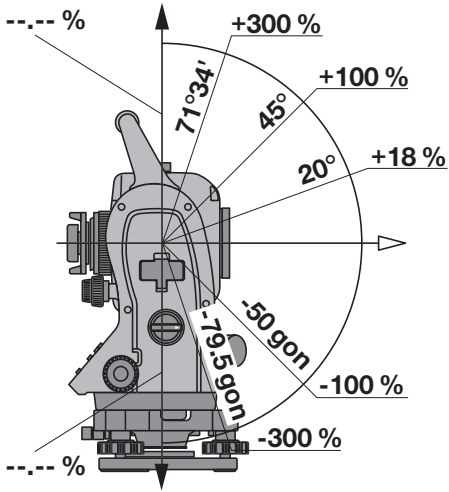

POS 15/18 total station

It is essential that the operating instructions are read before the tool is operated for the first time.

Always keep these operating instructions together with the tool.

Ensure that the operating instructions are with the tool when it is given to other persons.

1 These numbers refer to the corresponding illustrations. The illustrations can be found on the fold-out cover pages. Keep these pages open while studying the operating instructions.

In these operating instructions, the designation “the tool” always refers to the POS 15 or POS 18.

Rear casing section 1

- ① Left battery compartment with cover retaining screw

- ② Tribrach footscrew
- ③ Tribrach lock
- ④ Touch screen control panel
- ⑤ Focussing knob
- ⑥ Eyepiece
- ⑦ Telescope with laser distancer
- ⑧ Alignment sight (sighting aid)

Front casing section 2

- ⑩ Vertical drive
- ⑪ USB interface connectors (small and large)
- ⑫ Right battery compartment with cover retaining screw
- ⑬ Horizontal drive
- ⑭ Tribrach footscrew
- ⑮ Tribrach
- ⑯ Laser plummet
- ⑰ Guide light
- ⑱ Objective lens
- ⑲ Carrying handle

Contents

1	General information	4
1.1	Safety notices and their meaning	4
1.2	Explanation of the pictograms and other information	5
2	Description	5
2.1	Use of the product as directed	5
2.2	Description of the tool	5
2.3	Items supplied as standard	6
3	Accessories	6
4	Technical data	8
5	Safety instructions	9
5.1	Basic information concerning safety	9
5.2	Misuse	9
5.3	Proper organization of the work area	10
5.4	Electromagnetic compatibility	10
5.4.1	Laser classification for Laser Class 2 products	10
5.4.2	Laser classification for Laser Class 3R products	10
5.5	General safety rules	10
5.6	Transport	11
6	Description of the system	11
6.1	General terms	11
6.1.1	Coordinates	11
6.1.2	Control lines	11

6.1.3	Technical terms	12
6.1.4	Telescope positions 4 8	13
6.1.5	Terms and their description	13
6.1.6	Abbreviations and their meaning	14
6.2	Angle measurement system	15
6.2.1	Measuring principle	15
6.2.2	Dual-axis compensator 5	15
6.3	Distance measurement	15
6.3.1	Distance measurement 6	15
6.3.2	Targets	16
6.3.3	Reflector rod	16
6.4	Height measurement	17
6.4.1	Height measurement	17
6.5	Guide light	18
6.5.1	Guide light 7	18
6.6	Laser pointer 6	18
6.7	Data points	18
6.7.1	Selecting points	18
7	First steps	20
7.1	Batteries	20
7.2	Charging the battery	20
7.3	Inserting and changing the battery 8	20
7.4	Checking functions	20
7.5	Control panel	20
7.5.1	Function buttons	20
7.5.2	Size of the touch screen	21
7.5.3	Division of the touch screen	21
7.5.4	Touch screen – numerical keyboard	21
7.5.5	Touch screen – alphanumerical keyboard	22
7.5.6	Touch screen – general operating controls	22
7.5.7	Laser pointer status indicator	22
7.5.8	Battery condition indicators	22
7.6	Switching on / off	23
7.6.1	Switching on	23
7.6.2	Switching off	23
7.7	Setting up the tool	23
7.7.1	Setting up over a mark on the floor or ground using the laser plummet	23
7.7.2	Setting up the tool 9	23
7.7.3	Setting up over a pipe using the laser plummet	24
7.8	Theodolite application	24
7.8.1	Setting the horizontal circle display	25
7.8.2	Entering a circle reading manually	25
7.8.3	Zeroing the circle reading	26
7.8.4	Inclination indicator 10	26
8	System settings	27
8.1	Configuration	27
8.1.1	Settings	27
8.2	Time and date	29
9	Function menu (FNC)	30
9.1	Guide light 7	30
9.2	Laser pointer 6	31
9.3	Display illumination	31

9.4	Electronic bubble level	31
9.5	Correction of atmospheric influences	31
9.5.1	Correction of atmospheric influences	32
10	Functions required for various applications	32
10.1	Projects	32
10.1.1	Showing the active project	32
10.1.2	Selecting a project	33
10.1.3	Creating a new project	33
10.1.4	Project information	34
10.2	Setting a station and orientation	34
10.2.1	Overview	34
10.2.2	Setting a station over a point with control lines	35
10.2.3	Setting a station “anywhere”, with building control lines	38
10.2.4	Setting a station over a point with coordinates	41
10.2.5	Setting a station “anywhere”, with coordinates	43
10.3	Setting the height	46
10.3.1	Setting a station with a control line (height option “on”)	46
10.3.2	Setting a station with coordinates (height option “on”)	48
11	Applications	50
11.1	Horizontal layout (Horz. layout)	50
11.1.1	The horizontal layout principle	50
11.1.2	Laying out with building control lines	51
11.1.3	Laying out with coordinates	54
11.2	Vertical layout (Vert. layout)	57
11.2.1	The vertical layout principle	57
11.2.2	Vertical layout with building control lines	58
11.2.3	Vertical layout with coordinates	61
11.3	As-built	63
11.3.1	The principle of “As-built”	63
11.3.2	As-built with building control lines	64
11.3.3	As-built with coordinates	66
11.4	Missing line	67
11.4.1	The principle of “Missing line”	67
11.5	Measure and record	70
11.5.1	The principle of “Measure and record”	70
11.5.2	Measure and record with building control lines	70
11.5.3	Measure and record with coordinates	72
11.6	Vertical alignment	73
11.6.1	The principle of “Vertical alignment”	73
11.7	Area measurement	74
11.7.1	The principle of area measurement	74
11.8	Indirect height measurement	76
11.8.1	The principle of indirect height measurement	76
11.8.2	Indirect height measurement	77
11.9	Determining a point in relation to an axis	78
11.9.1	The principle of “Point in relation to axis”	78
11.9.2	Determining the axis	78
11.9.3	Checking points in relation to the axis	79
12	Data and data handling	80
12.1	Introduction	80

12.2	Point data	80
12.2.1	Points in the form of measured points	80
12.2.2	Points in the form of coordinate points	80
12.2.3	Points with graphical elements	80
12.3	Generation of point data	80
12.3.1	With the total station	80
12.3.2	With Hilti PROFIS Layout	81
12.4	Data memory	81
12.4.1	Total station internal memory	81
12.4.2	USB memory	81
13	Total station data manager	81
13.1	Overview	81
13.2	Selecting a job	82
13.2.1	Fixed points (control points or layout points)	83
13.2.2	Measured points	84
13.3	Deleting a project	86
13.4	Creating a new project	87
13.5	Copying a project	87
14	Exchanging data with a PC	88
14.1	Introduction	88
14.2	HILTI PROFIS Layout	88
14.2.1	Data types	88
14.2.2	Hilti PROFIS Layout data output (export)	89
14.2.3	Hilti PROFIS Layout data input (import)	89
15	Calibration and adjustment	89
15.1	In-the-field calibration	89
15.2	In-the-field calibration	90
15.3	Hilti Calibration Service	92
16	Care and maintenance	93
16.1	Cleaning and drying	93
16.2	Storage	93
16.3	Transport	93
17	Disposal	93
18	Manufacturer's warranty	94
19	FCC statement (applicable in US) / IC statement (applicable in Canada)	94
20	EC declaration of conformity (original)	95

1 General information

1.1 Safety notices and their meaning

DANGER

Draws attention to imminent danger that will lead to serious bodily injury or fatality.

WARNING

Draws attention to a potentially dangerous situation that could lead to serious personal injury or fatality.

CAUTION

Draws attention to a potentially dangerous situation that could lead to slight personal injury or damage to the equipment or other property.

NOTE

Draws attention to an instruction or other useful information.

1.2 Explanation of the pictograms and other information

Symbols



Read the operating instructions before use.



General warning



Return waste material for recycling.



Do not look into the beam.



Do not turn the screw

Symbol for Laser Class II / Class 2



Laser class II according to CFR 21, § 1040 (FDA)



Laser class 2 according to EN 60825:2008

Symbol for Laser Class III / Class 3



Laser class II according to CFR 21, § 1040 (FDA)



Do not look into the beam with the naked eye or with optical instruments.

Laser exit aperture



Laser exit aperture

Location of identification data on the tool

The type designation and serial number can be found on the type identification plate on the tool. Make a note of this data in your operating instructions and always refer to it when making an enquiry to your Hilti representative or service department.

Type: _____

Generation: 01 _____

Serial no.: _____

en

2 Description

2.1 Use of the product as directed

The tool is designed for measuring distances and directions, calculating target positions in 3 dimensions and the values derived from these positions and for laying out points using given coordinates or values relative to a control line.

To avoid the risk of injury, use only genuine Hilti accessories and insert tools.

Observe the information printed in the operating instructions concerning operation, care and maintenance.

Take the influences of the surrounding area into account. Do not use the appliance where there is a risk of fire or explosion.

Modification of the tool is not permissible.

2.2 Description of the tool

The POS 15/18 total station can be used to determine the exact position of objects or points. The tool is equipped with horizontal and vertical circles with digital graduation, two electronic levels (compensators), a coaxial laser distance incorporated in the telescope and an electronic processor system for calculating and saving data.

Hilti PROFIS Layout, a PC application provided by Hilti, can be used to transfer data in both directions between the total station and a PC, for data processing and for exporting data to other systems.

2.3 Items supplied as standard

- 1 Total station
- 1 AC adapter incl. charging cable for chargers
- 1 Charger
- 2 3.8 V 5200 mAh Li-ion battery
- 1 Reflector rod
- 1 POW 10 adjusting key
- 2 Laser warning plate
- 1 Manufacturer's certificate
- 1 Operating instructions
- 1 Hilti toolbox
- 1 Optional: Hilti PROFIS Layout (PC software on CD-ROM)
- 1 Optional: Copy protection dongle for PC software
- 1 Optional: USB data cable

3 Accessories

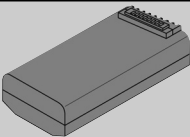
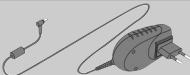
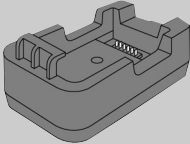

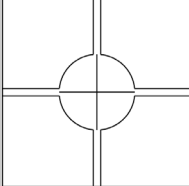
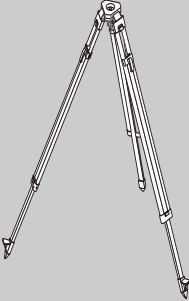
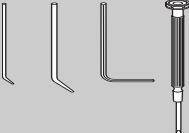

Illustration	Designation	Description
	POA 80 battery	
	POA 81 AC adapter	
	POA 82 charger	
	POA 50 reflector rod (metric)	The POA 50 (metric) reflector rod (consisting of four sections (each with a length of 300 mm), the rod point (length 50 mm) and the reflector plate (height 100 mm or, respectively, 50 mm to the middle)) is used to take readings from points on the ground.

Illustration	Designation	Description
	<p>POA 51 reflector rod (imperial)</p>	<p>The POA 51 (imperial) reflector rod (consisting of four sections (each with a length of 12"), the rod point (length 2.03") and the reflector plate (height 3.93" or, respectively, 1.97" to the middle)) is used to take readings from points on the ground.</p>
	<p>POAW-4 reflector foil</p>	<p>A self-adhesive foil for placing reference points on raised targets such as walls or posts.</p>
	<p>PUA 35 tripod</p>	
	<p>POW 10 adjusting key</p>	<p>For use by appropriately experienced persons only!</p>
	<p>Hilti PROFIS Layout</p>	<p>PC application that allows positions (points) to be generated from CAD data and transferred to the tool.</p>
	<p>POA 91 copy protection dongle</p>	
	<p>POW 90 data cable</p>	

4 Technical data

Right of technical changes reserved.

NOTE

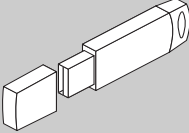
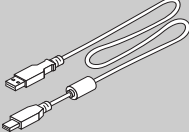
The only difference between the two tools is their angle measurement accuracy.

en

Telescope

Telescope magnification	30x
Shortest target distance	1.5 m (4.9 ft)
Telescope angle of view	1° 20': 2.3 m / 100 m (7.0 ft / 300 ft)
Objective lens aperture	45 mm (1.8")

Compensator

Type	Dual-axis, liquid
Working range	±3'
Accuracy	2"

Angle measurement

POS 15 accuracy (DIN 18723)	5"
POS 18 accuracy (DIN 18723)	3"
Angle reading system	Diametral

Distance measurement

Range	340 m (1000 ft) Kodak 90% gray
Accuracy	±3 mm + 2 ppm (0.01 ft + 2 ppm)
Laser class	Class 3R, visible, 630-680 nm, $P_o < 4.75$ mW, $f = 320$ -400 MHz (EN 60825-1/ IEC 60825-1); Class III (CFR 21 § 1040 (FDA))

Guide light

Aperture angle	1.4°
Typical range	70 m (230 ft)

Laser plummet

Accuracy	1.5 mm at 1.5 m (1/16 at 3 ft)
Laser class	Class 2, visible, 635 nm, $P_o < 10$ mW (EN 60825-1/ IEC 60825-1); Class II (CFR 21 §1040 (FDA))

Data memory

Memory size (data blocks)	10,000
Data transfer interfaces	Host and client, 2 x USB

Display

Type	Color display (touch screen), 320 x 240 pixels
Illumination	5 levels
Contrast	Day / night mode selectable

IP protection class

Class	IP 56
-------	-------

Horizontal drive

Type	Continuous
------	------------

Tripod thread

Tribrach thread	5/8"
-----------------	------

POA 80 battery

Type	Li-ion
Rated voltage	3.8 V
Battery capacity	5,200 mAh
Charging time	4 h
Battery life (with distance / angle measurement every 30 seconds)	16 h
Weight	0.1 kg (0.2 lbs)
Dimensions	67 mm x 39 mm x 25 mm (2.6" x 1.5" x 1.0")

POA 81 AC adapter and POA 82 charger

AC supply	100...240 V
AC frequency	47...63 Hz
Rated current input	4 A
Rated voltage	5 V
Weight (POA 81 AC adapter)	0.25 kg (0.6 lbs)
Weight (POA 82 charger)	0.06 kg (0.1 lbs)
Dimensions (POA 81 AC adapter)	108 mm x 65 mm x 40 mm (4.3" x 2.6" x 0.1")
Dimensions (POA 82 charger)	100 mm x 57 mm x 37 mm (4.0" x 2.2" x 1.5")

Temperature

Operating temperature range	-20... +50°C (-4°F to +122°F)
Storage temperature range	-30... +70°C (-22°F to +158°F)

Dimensions and weights

Dimensions	149 mm x 145 mm x 306 mm (5.9" x 5.7" x 12")
Weight	4.0 kg (8.8 lbs)

5 Safety instructions

5.1 Basic information concerning safety

In addition to the information relevant to safety given in each of the sections of these operating instructions, the following points must be strictly observed at all times.

5.2 Misuse

The tool and its ancillary equipment may present hazards when used incorrectly by untrained personnel or when used not as directed.



- Never use the tool without having received the appropriate instruction on its use or without having read these operating instructions.
- Do not render safety devices ineffective and do not remove information and warning notices.
- Have the tool repaired only at a Hilti Service Center. Failure to follow the correct procedures when

opening the tool may cause emission of laser radiation in excess of class 3R.

- d) Modification of the power tool or tampering with its parts is not permissible.
- e) The grip is designed to have a certain amount of play at one side. This is not a fault. It serves to protect the alidade. Tightening the screws on the grip may cause damage to the thread, making costly repairs necessary. **Do not tighten any screws on the grip!**
- f) To avoid the risk of injury, use only genuine Hilti accessories and additional equipment.
- g) **Do not use the tool in areas where there is a danger of explosion.**
- h) Use only clean, soft cloths for cleaning. If necessary, they may be moistened with a little alcohol.
- i) **Keep laser tools out of reach of children.**
- j) Measurements to plastic foam surfaces, e.g. polystyrene foam, to snow or to highly reflective surfaces, may result in incorrect readings.
- k) Measurements taken to surfaces with low reflectivity in highly reflective surroundings may be inaccurate.
- l) Measurements taken through panes of glass or other objects may be inaccurate.
- m) Rapid changes in the conditions under which the measurement is taken, e.g. persons walking through the laser beam, may lead to inaccurate results.
- n) Do not point the tool toward the sun or other powerful light sources.
- o) Do not use the tool as a level.
- p) Check the tool before taking important measurements or after it has been dropped or subjected to mechanical effects such as impact or vibration.

5.3 Proper organization of the work area

- a) Secure the area in which you are working and take care to avoid directing the beam toward other persons or toward yourself when setting up the tool.
- b) Use the tool only within the defined application limits, i.e. do not take readings from mirrors, stainless steel or polished stone, etc.
- c) Observe the accident prevention regulations applicable in your country.

5.4 Electromagnetic compatibility

Although the tool complies with the strict requirements of the applicable directives, Hilti cannot entirely rule out the possibility of the tool

- causing interference to other devices (e.g. aircraft navigation equipment) or being subject to
- interference caused by powerful electromagnetic radiation, leading to incorrect operation.

Check the accuracy of the tool by taking measurements by other means when working under such conditions or if you are unsure.

5.4.1 Laser classification for Laser Class 2 products

The laser plummet incorporated in the tools conforms to Laser Class 2 based on the IEC825-1 / EN60825-

01:2008 standard and to CFR 21 § 1040 (Laser Notice 50). The eyelid closure reflex protects the eyes when a person looks into the beam unintentionally for a brief moment. This eyelid closure reflex, however, may be negatively affected by medicines, alcohol or drugs. This tool may be used without need for further protective measures. Nevertheless, as with the sun, one should not look directly into sources of bright light. Do not direct the laser beam toward persons.

5.4.2 Laser classification for Laser Class 3R products

The measuring laser incorporated in the tools for distance measurement conforms to Laser Class 3R based on the IEC825-1 / EN60825-1:2008 standard and to CFR 21 § 1040 (Laser Notice 50). This tool may be used without need for further protective measures. Do not stare into the beam and do not direct the beam toward other persons.

- a) Tools of the laser class 3R and class IIIa should be operated by trained personnel only.
- b) The area in which the tool is in use must be marked with laser warning signs.
- c) The plane of the laser beam should be well above or well below eye height.
- d) Precautions must be taken to ensure that the laser beam does not unintentionally strike highly reflective surfaces.
- e) Precautions must be taken to ensure that persons do not stare directly into the beam.
- f) The laser beam must not be allowed to project beyond the controlled area.
- g) When not in use, laser tools should be stored in an area to which unauthorized persons have no access.

5.5 General safety rules

- a) **Check the tool for damage before use.** If the tool is found to be damaged, have it repaired at a Hilti service center.
- b) **Operating and storage temperatures must be observed.**
- c) **Check the accuracy of the tool after it has been dropped or subjected to other mechanical stresses.**
- d) **When the tool is brought into a warm environment from very cold conditions, or vice-versa, allow it to become acclimatized before use.**
- e) **When a tripod is used, check that the tool is securely mounted (screwed on) and that the tripod stands securely on solid ground.**
- f) **Keep the laser exit aperture clean to avoid measurement errors.**
- g) **Although the tool is designed for the tough conditions of jobsite use, as with other optical and electronic instruments (e.g. binoculars, spectacles, cameras) it should be treated with care.**
- h) **Although the tool is protected to prevent entry of dampness, it should be wiped dry each time before being put away in its transport container.**
- i) **As a precaution, check the previous settings or any adjustments you may have made.**

- j) View the tool at an angle when setting it up with the aid of the circular bubble level.
- k) Secure the battery compartment cover carefully in order to ensure that the battery cannot fall out and that no contact can occur which would result in the tool being switched off inadvertently possibly resulting in loss of data.

5.6 Transport

The batteries must be insulated or removed from the tool before the tool is shipped or sent by mail. Leaking batteries may damage the tool.

To avoid pollution of the environment, the tool and the batteries must be disposed of in accordance with the currently applicable national regulations.

Consult the manufacturer if you are unsure of how to proceed.

en

6 Description of the system

6.1 General terms

6.1.1 Coordinates

On some construction sites, instead of or in combination with control lines, additional points are marked out and their positions described by coordinates.

The coordinates used are generally based on the national coordinate system which is also usually taken as a basis for maps of the country.

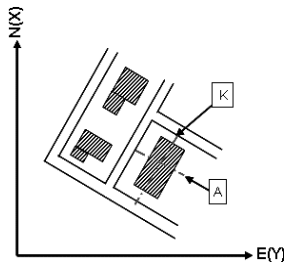

6.1.2 Control lines

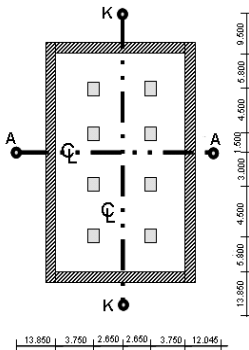

Height marks and control lines are generally marked out on and around the building plot by a surveyor before construction begins.

Two ends are marked on the ground for each control line.

These marks are used to position the individual components of the building or structure. Large buildings require a number of control lines.

6.1.3 Technical terms

Tool axes

en

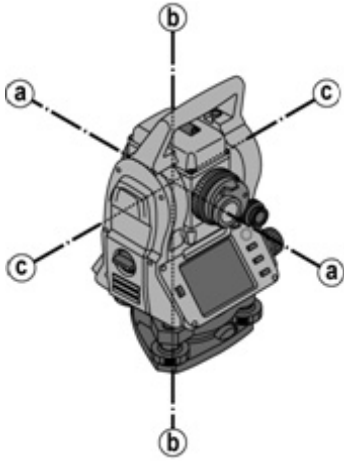

a	Sighting axis	_____
b	Vertical axis	_____
c	Trunnion (tilt axis)	_____

Horizontal circle / horizontal angle

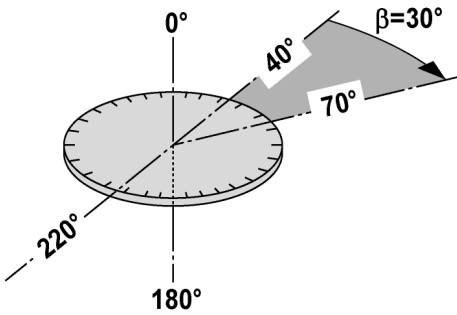

The included angle of $70^\circ - 40^\circ = 30^\circ$ can be calculated from the horizontal circle readings of 70° to one target and 30° to the other target.

Vertical circle / vertical angle

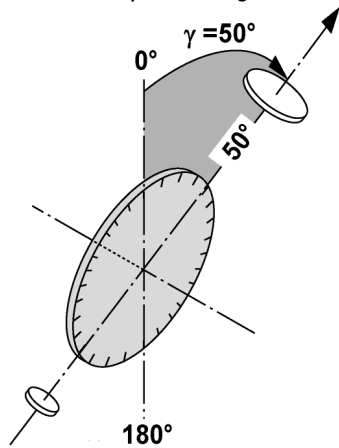

As the vertical circle is aligned at 0° to the direction of gravity or at 0° to horizontal, angles are determined relative to the direction of gravity, so to speak.

Using these values, the horizontal distance and vertical distance are calculated from the measured slope distance.

6.1.4 Telescope positions 4 3

The term “telescope position” is used to ensure that readings from the horizontal circle can be correctly assigned to the vertical angle, i.e. the position of the telescope relative to the control panel determines in which “position” the measurements have been taken.

When the display and the eyepiece are immediately in front of you, then the tool is in telescope position 1. **4**

When the display and the objective lens are immediately in front of you, then the tool is in telescope position 2. **3**

6.1.5 Terms and their description

Sighting axis	The line through the cross hairs and center of the objective lens (telescope axis).
Trunnion	The telescope pivot (tilt) axis.
Vertical axis	The pivot axis of the entire tool.
Zenith	The zenith is the point that lies in the direction of gravity, but in the opposite, upward direction.
Horizon	The horizon is the direction perpendicular to the direction of gravity – generally known as horizontal.
Nadir	Nadir is the name given to the downward direction in which gravity acts.
Vertical circle	The vertical circle is the circle of angles described by the telescope when it is tilted upwards or downwards.
Vertical direction	A reading taken from the vertical circle is known as the vertical direction.
Vertical angle (VA)	A vertical angle is a reading from the vertical circle. The vertical circle is usually aligned with the direction of gravity with the aid of the compensator, with the zero point at the zenith.
Elevation angle	An elevation angle of zero refers to the horizon (horizontal plane). Positive angles are above horizontal (upwards) and negative angles are below horizontal (downwards).
Horizontal circle	The horizontal circle is the complete circle of angles described by the tool when it is rotated.
Horizontal direction	A reading taken from the horizontal circle is known as the horizontal direction.

Horizontal angle (HA)	A horizontal angle is the difference between two readings from the horizontal circle. However, a reading from one of the circles is also often described as an angle.
Slope distance (SD)	Distance from the center of the telescope to the point at which the laser beam strikes the target surface
Horizontal distance (HD)	The horizontal distance derived from the measured slope distance.
Alidade	The rotatable center part of the total station is known as the alidade. This part usually carries the control panel, bubble levels for leveling and, inside, the horizontal circle.
Tribrach	The tool stands on the tribrach which, for example, can be mounted on a tripod. The tribrach has three points of contact which can be adjusted vertically by adjusting screws.
Tool standpoint	This is the point at which the tool is set up - usually over a point marked on the ground.
Station height (Stat H)	The height of the point on the ground at the tool station (above a reference height).
Instrument height (HI)	The height from the point on the ground or floor to the center of the telescope.
Reflector height (HR)	The distance from the center of the reflector to the tip of the reflector rod.
Orientation (backsight) point	The target point used in conjunction with the tool station to determine the horizontal reference direction for the horizontal angle measurement.
EDM	E lectronic D istance M easurer (laser distancer / range meter).
East (E)	In a typical surveying coordinate system this value refers to the east-west direction.
North (N)	In a typical surveying coordinate system this value refers to the north-south direction.
Line (L)	This is the term used to describe a longitudinal measurement along a building control line or other reference line.
Offset (O)	This is the term used for a distance at right angles to a control line or other reference line.
Height (H)	Many values are referred to as heights. A height is a vertical distance from a reference point or reference surface.

6.1.6 Abbreviations and their meaning

HA	Horizontal angle
VA	Vertical angle
dHA	Delta horizontal angle
dVA	Delta vertical angle
SD	Slope distance
HD	Horizontal distance
dHD	Delta horizontal distance
HI	Instrument height
HR	Reflector height
BM height	Benchmark height
Stat H	Station height
h	Height
E	East
N	North
O	Offset
L	Line value

dH	Delta height
dE	Delta east
dN	Delta north
dOffs	Delta offset horz
dL	Delta line

6.2 Angle measurement system

6.2.1 Measuring principle

The tool calculates the angle in each case from two circle readings.
 For the purpose of distance measurement, pulses transmitted along a visible laser beam at a certain wavelength are reflected from the object to which the measurement is being taken.
 Distances can be determined from the values obtained from these pulses.

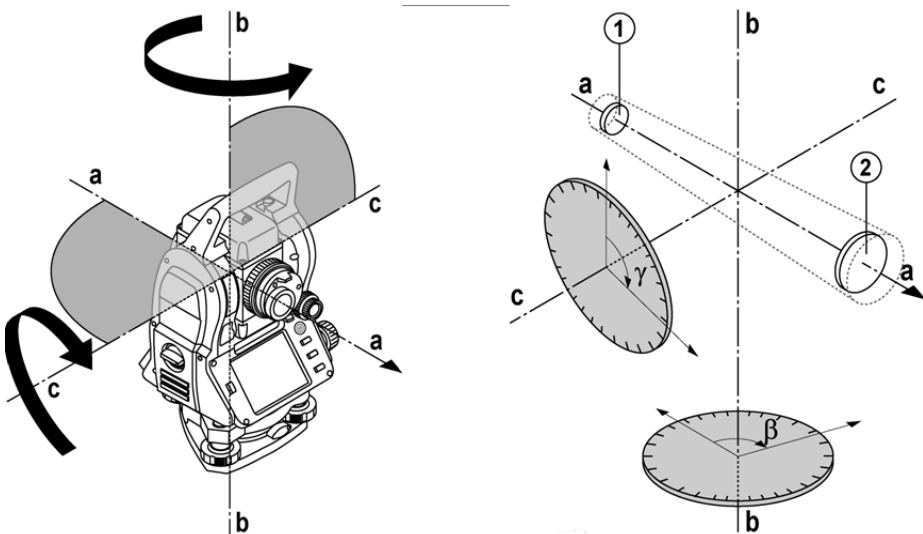

Tool inclination is determined with the aid of electronic levels (compensators), circle readings are corrected accordingly and the height difference is also calculated from the measured slope distance and horizontal distance.

The built-in microprocessor system allows conversion of all distance units between the metric and imperial systems (feet, yards, inches, etc.) and digital circle graduation allows various angle units to be shown, e.g. 360° sexagesimal graduation (° ' ") or gon (g) in which the full circle consists of 400g graduations.

6.2.2 Dual-axis compensator 5

A compensator is, in principle, an electronic leveling system that determines exactly the remaining inclination ("off level") of the axes of the total station after it has been set up.

The dual-axis compensator determines this remaining inclination of the tool with great accuracy in the line and offset axes.

All calculations are then corrected automatically to ensure that this remaining inclination has no influence on angle measurements.

6.3 Distance measurement

6.3.1 Distance measurement 6

Distance measurement is by way of a visible laser beam emitted through the center of the objective lens, i.e the laser distancer is coaxial.

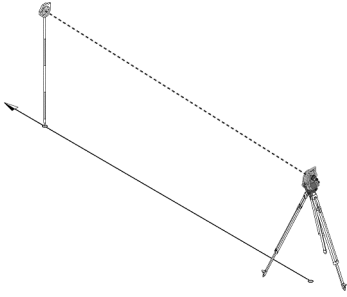

The laser beam takes measurements to “normal” surfaces without need for a special reflector. “Normal” surfaces are considered to be those that are not highly reflective. These surfaces may have a rough texture. Range depends on the reflectivity of the target surface, i.e. only slightly reflective surfaces such as those with a blue, red or green color may reduce the effective range. The tool is supplied complete with a reflector rod to which an adhesive reflective foil is attached. Taking readings from this reflector ensures reliable distance measurements even at long range. The reflector rod also allows distance measurements to be taken to points marked on the ground.

NOTE

Check at regular intervals to ensure that the visible laser distancer beam is correctly adjusted and in line with the sighting axis. Send the tool to your nearest Hilti Service Center if adjustment is found necessary or if you are unsure.

6.3.2 Targets

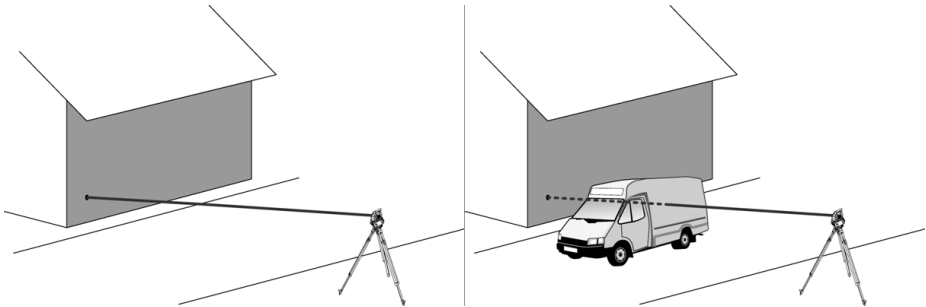

The laser beam is capable of measuring to any stationary target.

While a distance is being measured care must be taken to ensure that no other object moves through the laser beam.

NOTE

There is otherwise a risk that the distance will be measured to another object, not to the desired target.

6.3.3 Reflector rod

The POA 50 (metric) reflector rod (consisting of four sections (each with a length of 300 mm), the rod point (length 50 mm) and the reflector plate (height 100 mm or, respectively, 50 mm to the middle)) is used to take readings from points on the ground.

The POA 51 (imperial) reflector rod (consisting of four sections (each with a length of 12"), the rod point (length 2.03") and the reflector plate (height 3.93" or, respectively, 1.97" to the middle)) is used to take readings from points on the ground.

The reflector rod can be held perpendicular to the ground or floor with the aid of the built-in bubble level.

In order to ensure an unobstructed line of sight for the laser beam, the distance between the tip of the rod and the center of the reflector can be varied.

The pattern printed on the reflector foil ensures reliable measurement of distances and directions and allows a longer range than is possible with other target surfaces.

Reflector rod lengths	L1	L2	L3	L4	L5
POA 50 (metric)	100 mm	400 mm	700 mm	1,000 mm	1,300 mm
POA 51 (imperial)	4"	16"	28"	40"	52"

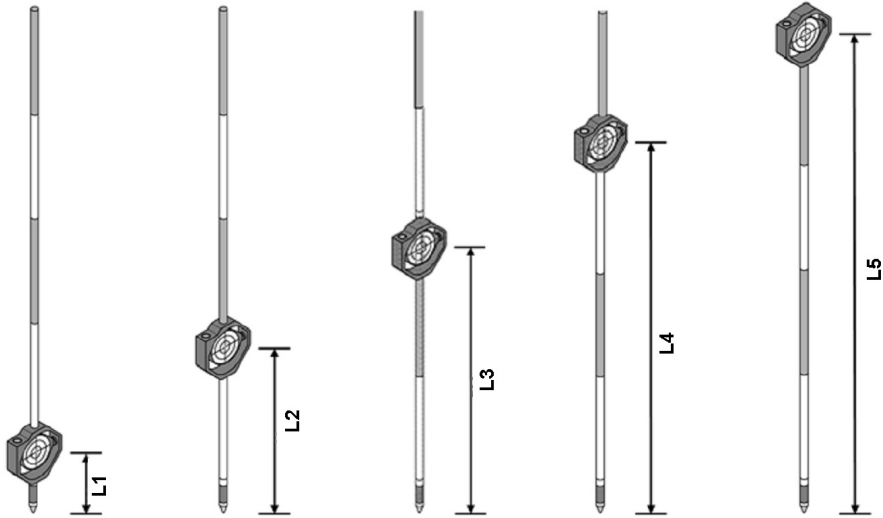

6.4 Height measurement

6.4.1 Height measurement

The tool can be used to measure heights or differences in height. Height measurements are made using the trigonometrical height measurement principle and are calculated accordingly.

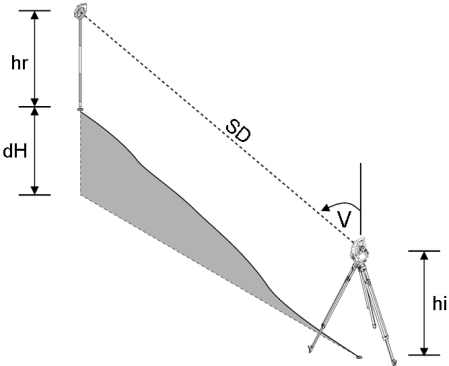

The height measurements take the **vertical angle** and the **slope distance** in conjunction with the **instrument height** and the **reflector height** into account.

$$dH = \cos(VA) \cdot SD + HI - HR + (corr)$$

In order to calculate the absolute height of the target point (point on the ground), the station height (Stat H) is added to the delta height.

$$H = Stat H + dH$$

6.5 Guide light

6.5.1 Guide light 7

The guide light can be switched on or off manually and the blink frequency adjusted to one of 4 different settings. The guide light consists of two red LEDs incorporated in the telescope unit. When switched on, one of the two LEDs blinks to clearly indicate whether the person is to the right or left of the sighting line. A person at a distance of at least 10 m from the tool and standing approximately on the sighting line will see either the blinking or steady light more brightly, depending on whether they are positioned to the right or left of the sighting line. The person is positioned on the sighting line when both LEDs are seen to have the same intensity.

6.6 Laser pointer 6

The laser beam projected by the tool can also be switched on permanently. When switched on permanently, the laser beam is often referred to as a "laser pointer". When working indoors, the laser pointer can also be used as an aiming device or, respectively, to indicate the direction in which measurements are being made. Outdoors, however, the beam is visible only under certain conditions so its use for this purpose is not really feasible.

6.7 Data points

The data from measurements taken with the Hilti total stations is used to generate measured points. Similarly, these measured points and their position descriptions are used in applications such as "Layout" or to define station locations. Hilti total stations incorporate various features that facilitate and speed up the process of selecting points.

6.7.1 Selecting points

Point selection forms an important integral part of a total station system as points are generally measured and used repeatedly for laying out, for stations, as orientation aids and for comparative measurements. Points can be selected in a number of different ways:

1. From a plan
2. From a list
3. Manual entry

Selecting points from a plan

Control points (fixed points) are available for selection in graphical form.

Points can be selected on the display by touching them with a finger or the point of a stylus.

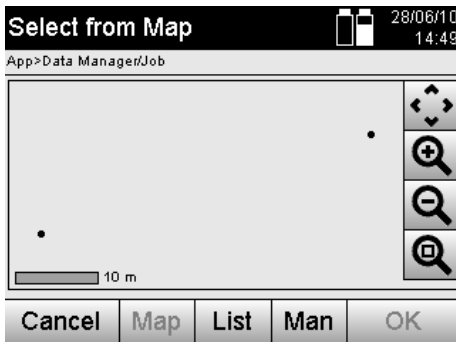

	Shows the point selected from the graphical display.
	Cancel and return to previous screen.
	Select a point by manual entry.
	Confirm and apply the entry.
	Show all points in the display area.

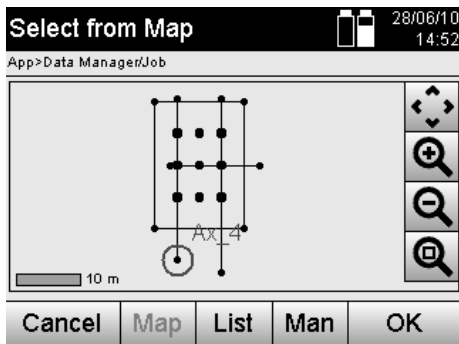

NOTE

Point data assigned to a graphical element cannot be edited or deleted on the total station. This can only be done using Hilti PROFIS Layout.

Selecting points from a list



Manual entry of points

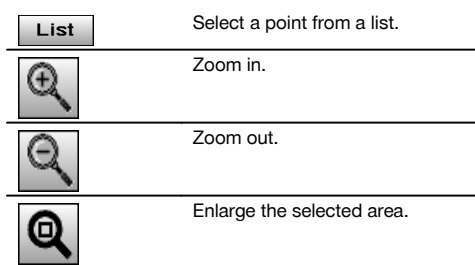
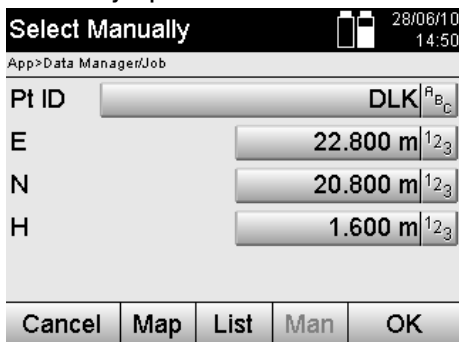

en

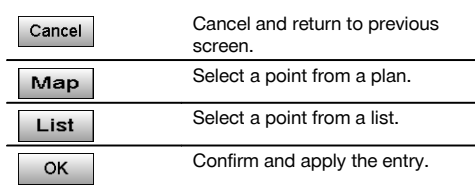
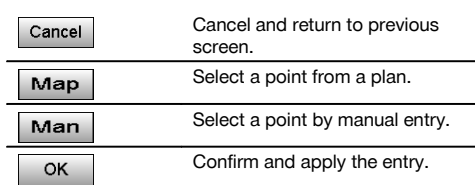

7 First steps

7.1 Batteries

The tool is equipped with two batteries which can supply power one after the other.

The current state of battery charge (both batteries) is always shown.

When changing batteries, one battery can remain in the tool and continue to provide power while the other battery is being charged.

When changing batteries while the tool is in operation and to prevent the tool switching itself off, it is recommended that the batteries are changed one after the other.

7.2 Charging the battery

After unpacking the tool, remove the AC adapter, charger and battery from their holders.

Charge the battery for approx. 4 hours.

7.3 Inserting and changing the battery

Insert the charged battery into the tool with the battery connector underneath and facing the tool.

Secure the battery compartment cover carefully.

7.4 Checking functions

NOTE

Please note that this tool makes use of friction clutches for pivoting about the alidade and thus does not have to be locked at the horizontal drives.

The horizontal and vertical drives are of the continuous type, similar to those of an optical level.

Check the functions of the tool before initial use and at regular intervals in accordance with the following criteria:

1. Pivot the tool carefully by hand to the left and right and tilt the telescope up and down to check operation of the friction clutches.
2. Turn the horizontal and vertical drives carefully in both directions.
3. Turn the focussing ring fully to the left. Look through the telescope and turn the eyepiece ring to bring the cross hairs into focus.
4. With a little practice you can check the two optical sights on the telescope to ensure that they are in alignment with the object targeted by the cross hairs.
5. Check to ensure that the cover for the USB interfaces is closed securely before further use of the tool.
6. Check that the screws on the carrying handle are tight.





7.5 Control panel

The control panel consists of a total of 5 buttons with symbols plus a touch screen for interactive operation.

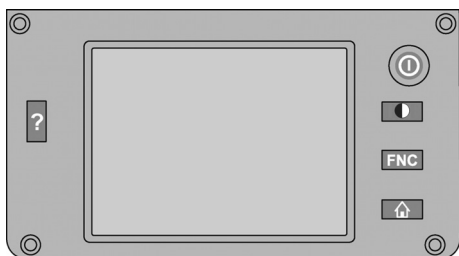
7.5.1 Function buttons

The function buttons are used for general operation of the tool.



	Switch the tool on or off.
	Switch the display backlight on or off.
	Select the FNC menu for additional settings.
	Cancel or end all active functions and return to the start menu.
	Show the help text for the current screen.

7.5.2 Size of the touch screen

The touch screen is approx. 74 x 56 mm (2.9 x 2.2 in) in size and has a resolution of 320 x 240 pixels.

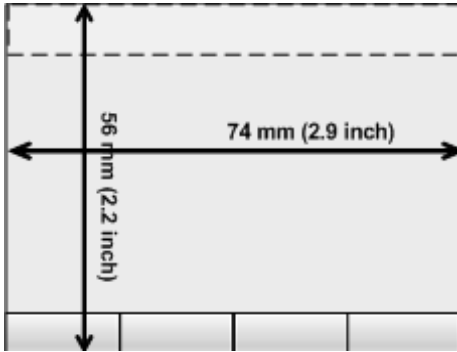

7.5.3 Division of the touch screen

The touch screen is divided into areas for operation of the tool and for displaying information to the user.

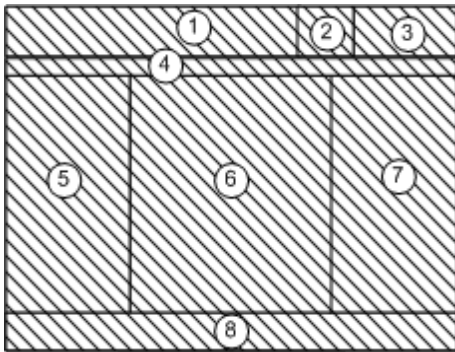

- ① Instructions and info for the user

- ② Battery and laser pointer status indicator

- ③ Time and date indicator and entry line

- ④ Menu hierarchy

- ⑤ Data field designations in ⑥

- ⑥ Data fields

- ⑦ Drawings to assist measuring operations

- ⑧ Bar containing up to 5 touch screen buttons

7.5.4 Touch screen – numerical keyboard

When numerical data is required to be entered, the appropriate keyboard appears in the display automatically. The keyboard layout is as shown in the illustration below.





-  Cancel Cancel and return to previous screen.

-  OK Confirm and apply the entry.

-  ← Move the cursor to the left.

-  → Move the cursor to the right.

-   Delete the character to the left of the cursor position. If there is no character to the left, the character at the cursor position will be deleted.

7.5.5 Touch screen – alphanumerical keyboard

When alphanumerical data is required to be entered, the appropriate keyboard appears in the display automatically. The keyboard layout is as shown in the illustration below.

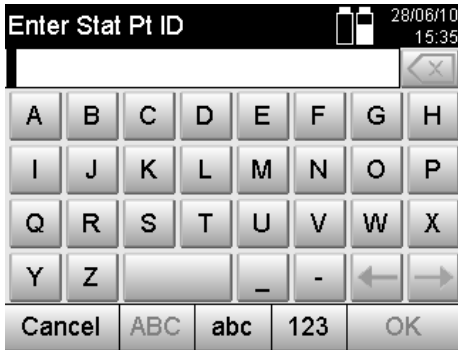

	Cancel and return to previous screen.
	Switch to lower case letters.
	Switch to numerical keys.
	Confirm and apply the entry.
	Move the cursor to the left.
	Move the cursor to the right.
	Delete the character to the left of the cursor position. If there is no character to the left, the character at the cursor position will be deleted.

7.5.6 Touch screen – general operating controls

	Application button - used to start an application or function.
	Button for direct entry of numerical data, including symbols and decimal points.
	Button for direct entry of alphanumerical characters, including upper and lower cases.
	Select from a list. These lists may contain numerical or alphanumerical values and settings.
	A drop-down menu. In most cases, these menus provide a maximum of three options for the selection of settings.
	Example of a button in the bottom line of the display.

7.5.7 Laser pointer status indicator

The tool is equipped with a laser pointer.

	Laser pointer ON
	Laser pointer OFF

7.5.8 Battery condition indicators

The tool uses 2 lithium-ion batteries which can supply power at the same time or one after the other, depending on requirements.

The tool switches from one battery to the other automatically.

One of the batteries can thus be removed at any time, e.g. for charging, while continuing to use the tool with the other battery - so long as its capacity allows.

NOTE

The state of battery charge is indicated by the extent to which the battery symbol is “filled”.

7.6 Switching on / off

7.6.1 Switching on

Press and hold the on/off button for approx. 2 seconds.

NOTE

If the tool is starting from a fully switched-off state, the complete start-up procedure takes approx. 20 – 30 seconds, during which two different screens are displayed consecutively.

The end of the start-up procedure has been reached when the tool shows that it requires to be leveled (see section 7.7.2).

7.6.2 Switching off



	Cancel and return to previous screen.
	The total station goes into sleep mode. When the on / off button is again pressed the system goes back into normal operating mode and returns to the place it was at before entering sleep mode.
	Switch off the total station completely.
	The total station will be restarted. Any data not already saved will be lost.

Press the on / off button.

NOTE

Please note that when switching off or restarting, the user is asked to confirm this action, just to be sure.

7.7 Setting up the tool

7.7.1 Setting up over a mark on the floor or ground using the laser plummet

The tool should always be set up over a point marked on the floor or ground so that in case of measurement deviations it is possible to fall back on the data for the station or orientation point.

The tool features a laser plummet that is switched on automatically together with the tool.

7.7.2 Setting up the tool 9

1. Set up the tripod with the center of the tripod head approximately over the point marked on the ground.
2. Mount the tool on the tripod by tightening the tripod screw and then switch the tool on.
3. Move two of the tripod legs with your hands until the laser beam strikes the mark on the ground.
NOTE Take care to ensure that the tripod head remains approximately horizontal.
4. Then press the points of the tripod legs into the ground by applying pressure with your foot.
5. Adjust the footscrews to eliminate any deviation of the laser point from the mark on the ground. The laser point must then be exactly in the center of the mark on the ground.
6. The circular bubble level can be centered by adjusting the tripod legs.
NOTE This is done by extending or retracting the leg at the opposite side of the tripod, depending on the direction in which the bubble is to be moved. This process may have to be repeated several times until the desired result is achieved.
7. Once the circular bubble level has been centered, align the laser plummet exactly with the mark on the ground by shifting the position of the tool laterally on the tripod plate.
8. Before the tool can be started, the electronic "bubble levels" must be centered by turning the footscrews so that the tool is reasonably level.

NOTE The arrows show in which direction the tribrach footscrews require to be turned in order to center the "bubbles".

The tool can be started once this has been achieved.

Level Tool

19/05/10
08:51

App>Start



OK



Increase laser plummet intensity (settings 1–4).



Reduce laser plummet intensity (settings 1–4).



Confirms leveling.



Laser plummet indicator symbol. The heavier the line, the more intense the laser plummet lights.



Electronic “bubble level” indicator. Center the bubbles.

9. Once the electronic “bubble levels” have been centered, check that the laser plummet is aligned exactly with the mark on the ground and shift the position of the tool laterally on the tripod plate if necessary.
10. Start the tool.

NOTE The OK button becomes active when the level bubbles for line (L) and offset (O) are within a total inclination of 45°.

7.7.3 Setting up over a pipe using the laser plummet

Pipes are often used to mark points on the ground.

In this case, the laser beam is projected into the pipe and the point cannot be seen.

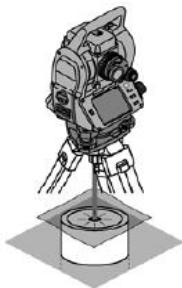
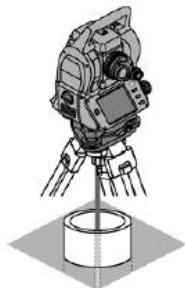

Lay a piece of paper, plastic foil or other semi-translucent material on the pipe in order to make the laser point visible.

7.8 Theodolite application

The theodolite application provides the basic theodolite functions for setting the horizontal circle for taking readings.

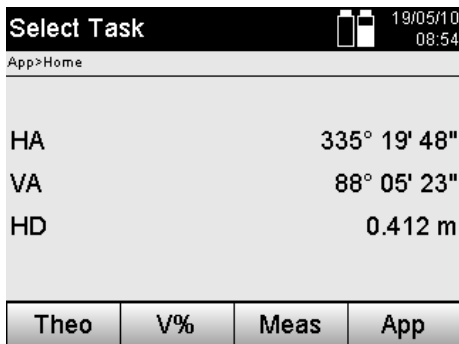

Theo

Select the "Theodolite" application for setting horizontal circle readings.

en

7.8.1 Setting the horizontal circle display

The horizontal circle reading is held, the tool aimed at the new target and the circle reading then released.

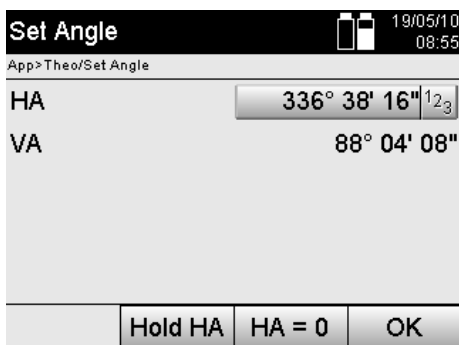

Hold HA

Pause current horizontal circle reading.

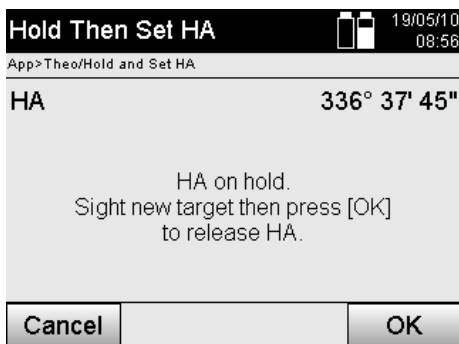

Cancel

Cancel and return to the previous screen without changing the horizontal value.

OK

Set horizontal value in the display.

7.8.2 Entering a circle reading manually

Any desired circle reading can be entered manually in any position.

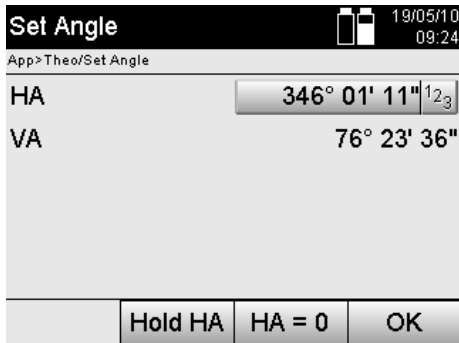

Enter the horizontal angle value manually.

Confirm the information shown.

7.8.3 Zeroing the circle reading

The option Hz “Zero” can be used to zero the horizontal circle reading quickly and easily.

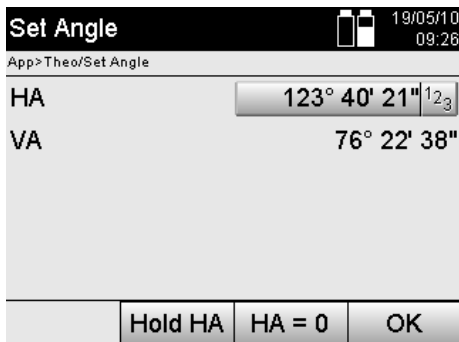

Set current horizontal angle to 0.

Quit function.

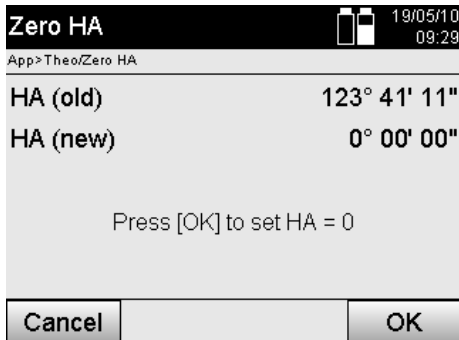

Cancel and return to the previous screen without changing the horizontal value.

Set horizontal value to zero.

7.8.4 Inclination indicator

Readings from the vertical circle can be shown in the display in degrees or in percent.

NOTE

Readings can be shown in % only for this function.

This allows inclinations to be measured in % or objects aligned accordingly.

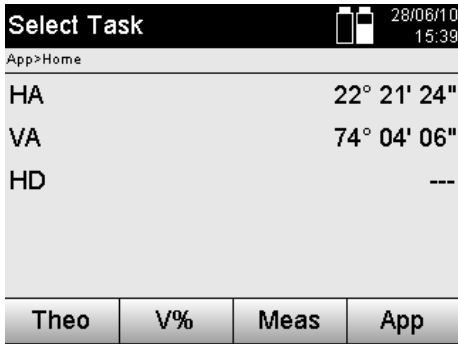

Toggle vertical angle display between degrees and %.

en

8 System settings

8.1 Configuration

When in the program menu, the configuration button is used to jump directly to the configuration button.

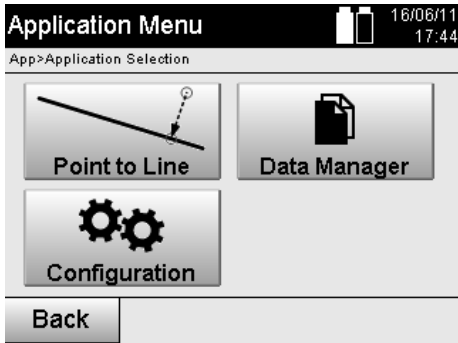

Return to previous view.



Select the configuration menu.

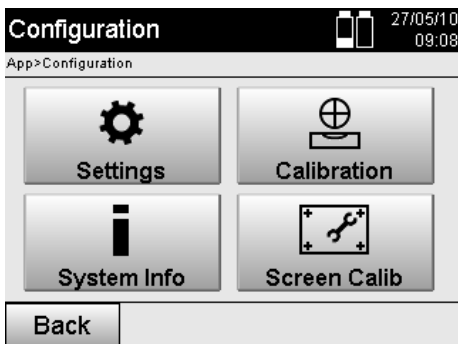

Cancel and return to previous screen.



Select the settings menu.



Show system info with serial number and software version.

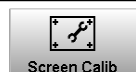

Select display calibration.

8.1.1 Settings

Settings for angles and distances, angular resolution and for zeroing the vertical circle.

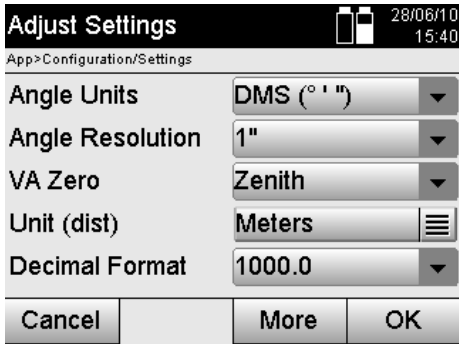

Cancel	Cancel and return to previous screen.
Next	Continue to the next screen where further settings can be made.
	Exit and save settings.

Settings for automatic shut-down parameters, beep tone and language selection.



Cancel	Cancel and return to previous screen.
Back	Return to previous view.
	Exit and save settings.

Possible settings

Angle units	GMS (° ' ") Gon
Angle resolution	1", 5", 10" 5cc, 10cc, 20cc
VA Zero	Zenith Horizon
Distance	Meters US feet, Int. feet, Ft/in 1/8, Ft/in 1/16
Decimal format	1000.0 1000,0
Auto on/off	ON Activates the time-dependent shut-down mode. The tool goes into sleep mode after approx. 5 min. OFF Deactivates the time-dependent shut-down mode.
Beep on/off	ON Activates a signal tone when an error occurs. OFF
Language	The touch screen language can be selected here.

8.2 Time and date

The tool is equipped with an electronic system clock that is capable of displaying the time and date in various formats, taking the different world time zones and switching between summer and winter time into account.

28/04/10
11:35

Select the menu for entering the date and time.

en

Entering the time and date in the following display

T. Zone

Select the screen for entering the time zone and changing automatically between summer and winter time.

OK

Save the values shown and return to previous screen.

Cancel

Cancel and return to previous screen.

OK

Save the values shown and return to previous screen.

Possible settings

Time format	12 hour
	24 hour
Date formats	DD/MM/YY = day/month/year
	MM/DD/YY = month/day/year
	YY/MM/DD = year/month/day

Time zones	GMT -12 hrs to GMT +13 hrs The time zones are identified by capital cities.
Auto summer time	ON
	OFF

en

9 Function menu (FNC)

The FNC button is used to select the function menu.
This menu selection can be made at any time.

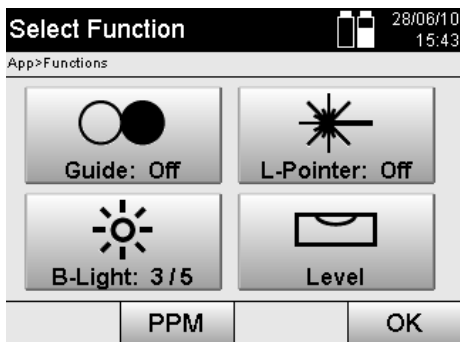

PPM

Menu for entering various atmospheric data.

OK

Apply settings and exit from the FNC menu.

9.1 Guide light 7

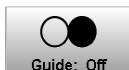
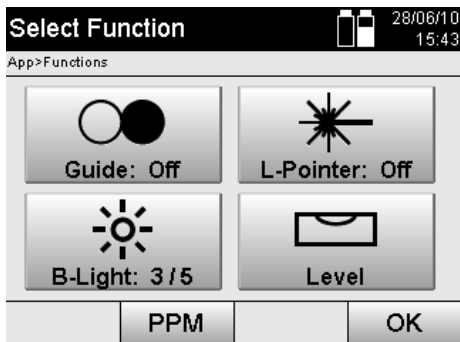

The guide light can be switched on or off and its blink frequency adjusted (sequence: off, 1 (slow) to 4 (fast)).

9.2 Laser pointer 6

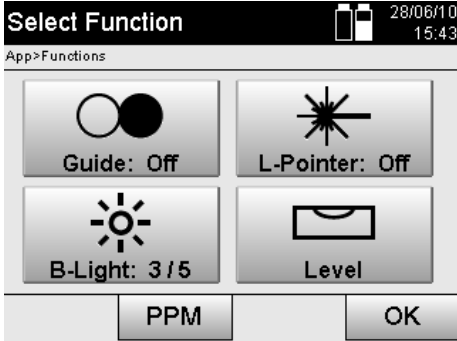

Switch the laser pointer on/off.

en

9.3 Display illumination

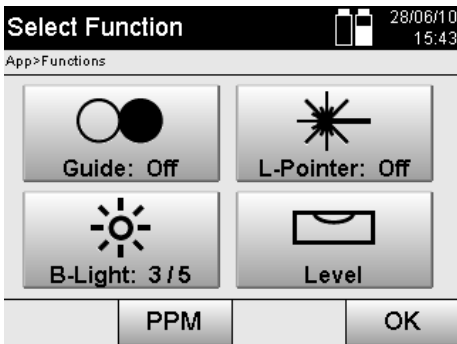

Switch display illumination on/off or vary its intensity. The brighter the display, the more power is consumed.

9.4 Electronic bubble level

See section 7.7.1 on setting up over a mark on the floor or ground using the laser plummet

9.5 Correction of atmospheric influences

The tool uses a visible laser beam for distance measurement.

As a fundamental principle, when light passes through the air its speed is reduced due to the density of the air. This influence varies according to the air density.

Air density depends to a great extent on air pressure and air temperature and to a significantly lesser extent on air humidity.

If distances are to be measured accurately it is essential that atmospheric influences are taken into account.

The tool calculates and corrects the corresponding distances automatically, but the temperature and pressure of the surrounding air must first be entered.

These parameters can be entered in various units.

9.5.1 Correction of atmospheric influences

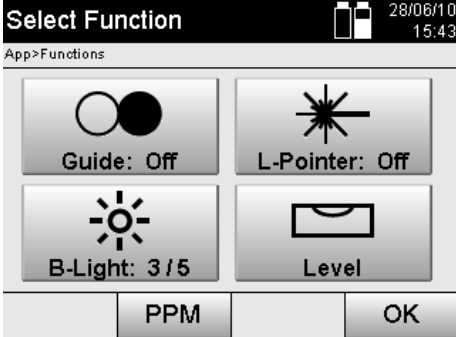

1. Select the option "ppm".

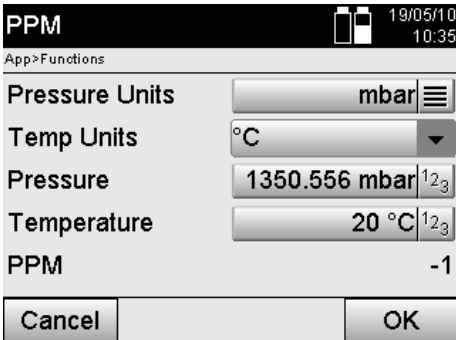

2. Select the applicable units and enter the pressure and temperature.

Settings for atmospheric influences and the units used

Units (pressure)	hPa
	mmHg
	mbar
	inHg
	psi
Units (temperature)	°C
	°F

PPM	Menu for entering various atmospheric data.
OK	Apply settings and exit from the FNC menu.

Cancel	Cancel and return to previous screen.
--------	---------------------------------------

10 Functions required for various applications

10.1 Projects

A project has to be opened or created before the total station is used for an application.

If at least one project already exists then the project selection screen will be displayed. If no project exists then the screen for creation of a new project will be displayed.

All data are assigned to the active project and saved accordingly.

10.1.1 Showing the active project

If one or more projects are already present in memory and one of these is to be used as the active project, the project has to be confirmed each time an application is restarted, when another project is selected or when a new project is created.

Current Job	
App>Horz. Layout/Job	
Job	Puent_1.2.5
Date	20/05/10
Time	08:55
No. Pts	3
No. Stats	1
Back	New OK

Back	Return to previous view.
New	Select or create a new project.
OK	Confirm that the project shown is the current project.

en

10.1.2 Selecting a project

Select current Job	
App>Horz. Layout/Job	
Tst	▲
Rejk_2010.96	
R0_st_1.9	
Puent_1.2.5	
BK_1.9	▼
Back	View New OK

Back	Return to previous view.
View	Show project information.
New	Select or create a new project.
OK	Confirm the selected project.

From the list shown, select the project that is to be used as the current project.

10.1.3 Creating a new project

All data is always assigned to a project.

A new project should be created when data is assigned to something new and the data is to be used only for that purpose.

The date and time of creation are saved when a new project is created and the number of stations and points within the project is set to zero.

Name New Job	
App>Data Manager/Job	
Job	--- ^A _B _C
Date	26/05/10
Time	15:29
Cancel	OK

--- ^A _B _C	Enter project name.
Cancel	Cancel and return to project selection.
OK	Confirm and apply the entry.

NOTE

An error message is displayed when an incorrect entry is made and the user is requested to re-enter the data.

10.1.4 Project information

The current status of the project is shown with the project information, e.g. date and time of creation, number of stations and total number of the points saved.

Current Job		20/05/10 09:11	
App>Horz. Layout/Job			
Job	Puent_1.2.5		
Date	20/05/10		
Time	08:55		
No. Pts	3		
No. Stats	1		
Back	New	OK	

OK

Confirm information shown and return to project selection.

10.2 Setting a station and orientation

Please pay particular attention to the information given in this section.

Setting a station is one of the most important operations when using a total station and must be carried out with great care.

One of the simplest and most reliable methods of achieving this involves setting up the tool over a (known) point on the floor or ground and using a reliable target point.

The possibility of setting the station “anywhere” offers greater flexibility but presents risks in that errors may not be identified and then transferred or multiplied as the work proceeds, etc...

Moreover, this possibility requires a little experience in selecting a position for the tool relative to the reference points used for position calculation.

NOTE

Please remember: If the station is set incorrectly, everything measured subsequently from this station will also be incorrect – i.e. the actual applications carried out such as measuring, layouts or staking out, etc...

10.2.1 Overview

In certain applications that make use of absolute positions, after physically setting up the tool, i.e. setting up the station, it is also necessary to set the position of the station with the applicable data, as in the application it is necessary to know the position at which the tool is standing.

This position can be defined by way of coordinates or by establishing a building control line.

This process is called **Set station**.

In addition to the position of the tool it is also necessary to know in which direction the reference axes lie or, respectively, the direction of the main axis.

In most cases where coordinates are used, the main axis runs northwards. Where control lines are used the main axis lies in the direction of the control line.

It is necessary to know the direction of the reference axis as the horizontal circle and its “zero mark” is, so to speak, rotated parallel to or in the direction of the main axis.

This process is called **Orientation**.

The alternative ways of setting the station can, so to speak, be used in two systems.

They can be used either in a building control line system where lengths and offset distances exist or are entered, or in a perpendicular coordinate system.

The station system or, respectively, the measuring system is fixed with the definition of the station.

4 alternative ways of setting the station

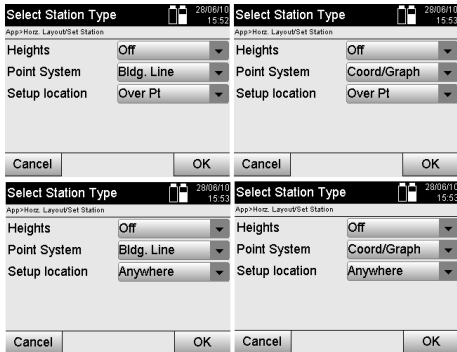

Cancel

Cancel and return to previous screen.

OK

Confirm selection and continue to station identification.

en

NOTE

The “Set station” process always includes setting a position and an orientation.

When one of the four applications is started, such as Horizontal Layout, Vertical Layout, As-Built or Measure and Record, a station and orientation always have to be set.

If, in addition, heights are also to be used, i.e. target heights are to be determined or laid out, the height of the center of the telescope must also be defined.

Summary of alternatives for setting the station (6 options)

Heights	<p>On, off This setting determines whether heights are to be calculated or shown.</p>
Point system	<p>Building control line Manually enter data that refers to the building control line (along the line or offset).</p>
Setup location	<p>Coord / Graph Use coordinates or graphic data from the plan / CAD.</p>
	<p>Over Pt The tool station is located over a point with a marked and known position.</p>
	<p>“Anywhere” The tool station can be set “anywhere”. The position of the station must be measured or calculated from measurement data.</p>

10.2.2 Setting a station over a point with control lines

The dimensions or position description of many parts of a structure are given in relation to a building control line on the plan.

With the total station, building control lines and their corresponding dimensions can also be used.

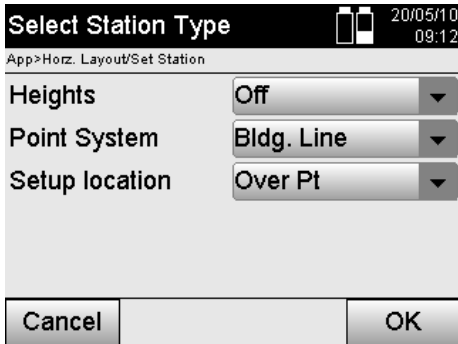

Cancel	Cancel and return to previous screen.
OK	Confirm selection and continue to station identification.

Setting up the tool over a point on a building control line

The tool is set up over a point marked on the building control line, from which the points or items to be measured are easily visible.

Special care must be taken to ensure that the tripod stands steadily and securely.

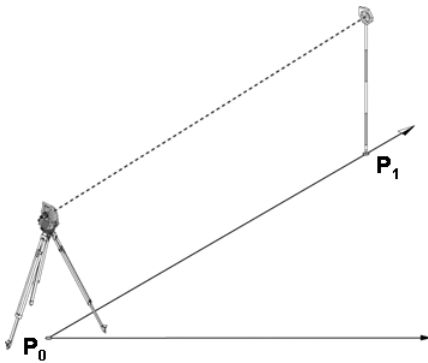

The position of the tool P_0 and the orientation point P_1 lie on a common building control line.

10.2.2.1 Entering the station position

A unique designation that clearly identifies the station or tool position must be entered as a unique designation is necessary for saving the station data.

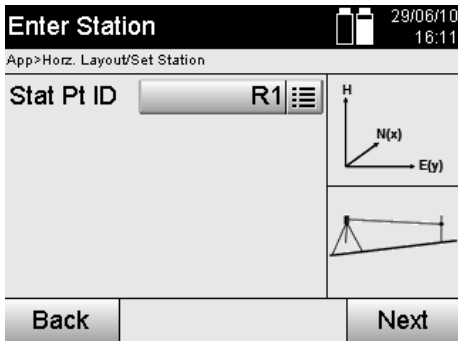

[Text Entry Icon]	Enter station names.
Back	Return to previous view.
Next	Confirm entry of station data and continue with orientation.

10.2.2.2 Entering the target point

A designation that clearly identifies the orientation point must be entered when data is saved.

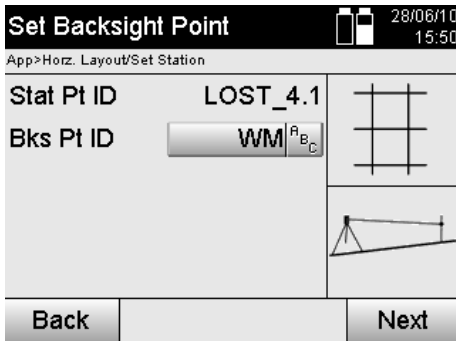

NO0B_S ^{A_{B,C}}	Enter name for the orientation point.
Back	Return to previous view.
Next	Continue to "Orientation measurement".
Meas	Measure angle and distance. Continue, showing the (re)calculated station height.

en

After the orientation point has been entered, a reading must be taken from the orientation point. When done so, the orientation point must be targeted as accurately as possible.

10.2.2.3 Setting a station with a control line

The station is set immediately after the angle measurement for orientation purposes.

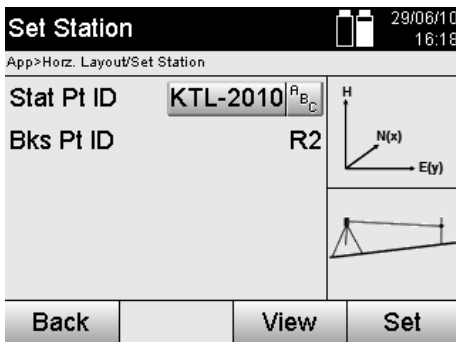

Back	Return to orientation measurement.
View	Show station data.
Set	Setting the station.

NOTE

The station is always saved in internal memory. If the station name already exists in memory, the station must be renamed. i.e. a new name assigned to it.

After the station has been set, the user can continue with the actual main application previously selected.

10.2.2.4 Shift and rotate axis

Shift axis

The axis starting point can be shifted in order to use a different reference point as the origin of the coordinate system. If the value entered is positive, the axis is moved forward. If it is negative, the axis is moved back. A positive value shifts the starting point to the right and a negative value shifts it to the left.

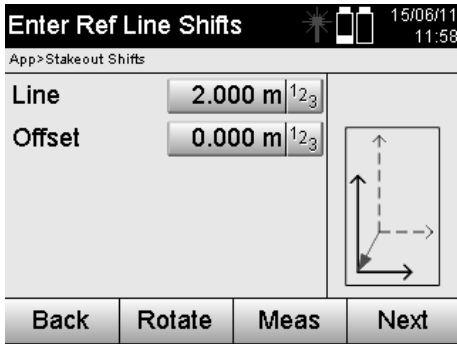

Back	Return to previous view.
	Enter axis shift manually.
Meas	Take measurement to point. The axis, distance and height values are shown. The values can be individually labeled.
Rotate	Rotate axis.
Next	Continue to the next step.

Rotating the axis

The axis bearing (direction) can be rotated about the starting point. If the value entered is positive, the axis is rotated clockwise. If it is negative, the axis is rotated counterclockwise.

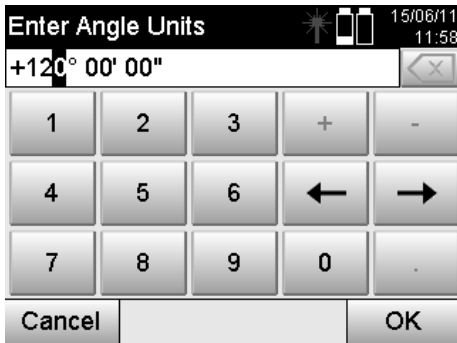

Back	Return to previous view.
OK	Confirm rotation.

After the station has been set, the user can continue with the actual main application previously selected.

10.2.3 Setting a station “anywhere”, with building control lines

Setting the station “anywhere” allows the position of the station to be defined by measuring the angles and distances to two reference points.

The ability to set the station “anywhere” is used when it is not possible to set it at a point on the building control line or when the line of sight to the points to be measured is obstructed.

Extra care must be taken when setting the station “anywhere”.

Additional measurements are taken in order to set the station “anywhere”. Additional measurements always present a risk of errors.

Care must also be taken to ensure that the geometry of the situation allows a usable position to be achieved.

The tool checks the basic geometric relationships in order to ensure that a usable position can be calculated and issues a warning in critical situations.

Nevertheless, the user of the tool is obliged to exercise special caution in this respect as the software is not capable of recognizing all potentially critical situations.

Select Station Type	
App>Horz. Layout/Set Station	
Heights	Off
Point System	Bldg. Line
Setup location	Anywhere
Cancel	OK

Cancel	Cancel and return to previous screen.
OK	Confirm selection and continue to station identification.

en

Setting up the tool “anywhere”, with building control lines

An unobstructed and convenient location should be chosen for setting up the tool, where two reference points on the same building control line are clearly visible and where a good line of sight to the points to be measured can be ensured as far as possible.

It is recommended that a mark is always first made on the ground or floor and the tool then set up over this mark. This allows the position to be checked subsequently in the event of uncertainties.

The following reference points to be measured must lie on the building control line or, if no control line exists, the building control line or reference axis are to be defined.

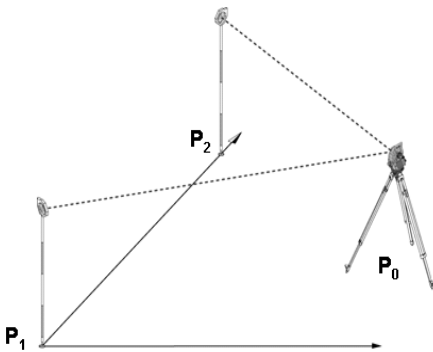

The position of the tool **P0** is not on the building control line. The measurement to the first reference point **P1** fixes the beginning of the control line, while the second measurement **P2** records the direction of the building control line in the system.

In the following applications line values are counted in the direction of the building control line, with 0.000 at the first reference point.

Offset values are counted as distances at right angles to the building control line.

10.2.3.1 Measuring to the first reference point on a control line

Measure Ref Pt 1  29/06/10 15:58

App>Horiz. Layout/Measure 1st Pt

Ref Pt 1 

HA 14° 39' 33"

VA 88° 56' 36"

HD ---



Back **Meas** **Next**

-  Enter the name of the orientation point.

- Return to previous view.

- Measure angle and distance.

- Continue to "Measure to the second reference point".

10.2.3.2 Measuring to the second reference point

Select Ref Point 2  16/06/11 17:59

App>Horiz. Layout/Station Setup

Ref Pt 2 

HA 28° 21' 30"

VA 77° 25' 05"

HD 4.220 m

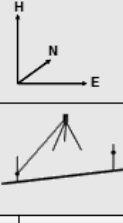

Back **Check D** **Meas** **Next**

- Return to "Measuring to the first reference point".

- Measure angle and distance.

- Continue to "Set station".

- Checking the distance between reference points

Continue by checking the distance between the station and the orientation point, as described in the applicable section.

10.2.3.3 Set station

The station is set immediately after the angle measurement for orientation purposes.

Set Station  29/06/10 16:06

App>Horiz. Layout/Set Station

Stat Pt ID 

Bks Pt ID

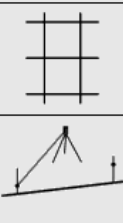

Back **View** **Set**

-  Alphanumeric field for entry of station name.

- Return to previous view.

- Show station data.

- Setting the station.

NOTE

The station is always saved in internal memory. If the station name already exists in memory, the station must be renamed. i.e. a new name assigned to it.

Continue with rotating the axis and shifting the axis as described in the applicable sections.

10.2.4 Setting a station over a point with coordinates

On many construction sites, measured points with coordinates already exist, or the positions of parts of the structure, building control lines or foundations etc. are already described with coordinates.

In this case, the decision about whether coordinates or building control lines are to be used can be taken when the station is being set up.

en

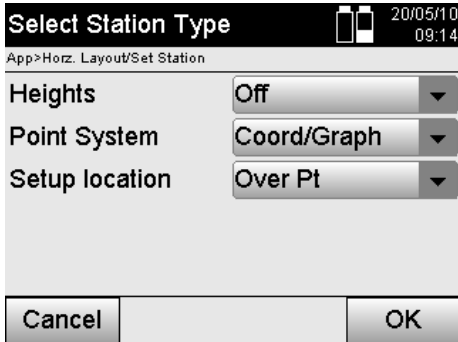

Cancel	Cancel and return to previous screen.
OK	Confirm selection and continue to station identification.

Setting up the tool over a point with coordinates

The tool is set up over a point marked on the floor or ground, the position of which is defined by coordinates and from which the points or items to be measured are easily visible.

Special care must be taken to ensure that the tripod stands steadily and securely.

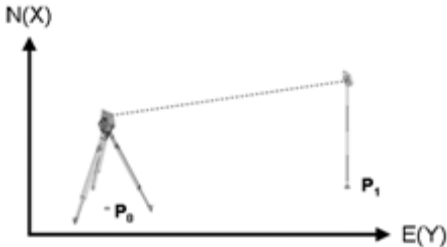

The tool is positioned at a point defined by coordinates **P0** and, for the purpose of orientation, is aimed at another point defined by coordinates **P1**.

The tool calculates the position within the coordinate system.

For better identification of the orientation point, the distance can be measured and compared with the coordinates.

NOTE

This makes correct identification of the orientation point more reliable. If the coordinate point **P0** also has a height, this will first be used as the station height. The height of the station can be redetermined and changed at any time before the station is set finally.

The orientation point is decisive for correct calculation of direction and should therefore be selected and measured with care.

10.2.4.1 Entering the position of the station

A designation that identifies the station or tool position clearly and uniquely must be entered. The coordinates of its position must belong to this designation.

i.e. the station point may already exist as a saved point in the job or, alternatively, the coordinates will have to be entered manually.

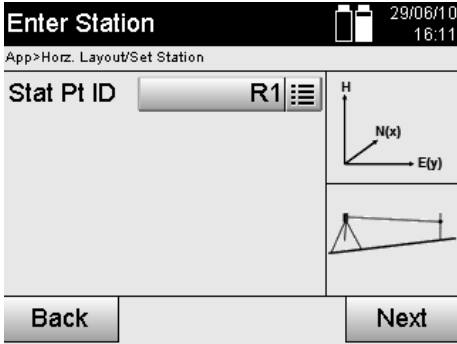

	Enter station names.
	Return to previous view.
	Confirm entry of station data and continue with orientation.

After the name for the station point has been entered, the corresponding coordinates or positions are searched for in the graphics data in memory.

If no point data exists under the given name the coordinates have to be entered manually.

10.2.4.2 Entering the target point

A designation that identifies the target point clearly and uniquely must be entered. The coordinates of its position must belong to this designation.

The target point must exist as a saved point in the job or, alternatively, the coordinates have to be entered manually.

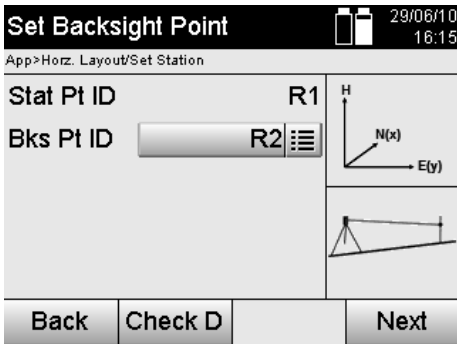

	Enter the name of the orientation point.
	Return to previous view.
	Check distance between the station and orientation point.
	Continue to "Set station".
	Measure angle and distance.

NOTE

When the name for the orientation point is entered, the corresponding coordinates or position are searched for in the graphics data saved in memory. If no point data exists under this name the coordinates have to be entered manually.

Optional check of distance between the station and the orientation point

After the target point has been entered, this point must be sighted exactly for the purpose of a reference measurement. After measuring the distance to the orientation point, you have the option of checking the distance between the station and the orientation point.

This serves as an aid for checking correct point selection and correct sighting of this point, and shows how well the measured distance corresponds to the distance measured from the coordinates.

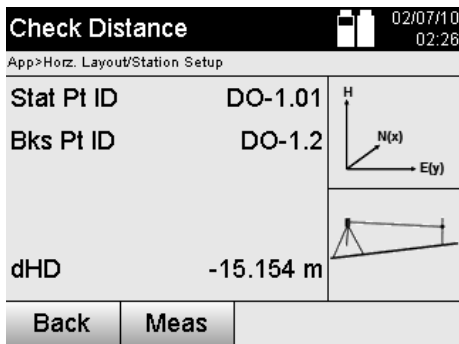

Back	Return to previous view.
Next	Continue to the next screen where further settings can be made.

en

The dHD value shown is the difference between the measured distance and the distance calculated from the coordinates.

Further points can be checked by pressing the “Next” button. In addition to the dHD, the dHA value (which is the difference between the measured horizontal angle and the horizontal angle calculated from the coordinates) is also shown in the display.

10.2.4.3 Set station

The station is always saved in internal memory.

If the station name already exists in memory, the station **must** be renamed. i.e. a new name assigned to it.

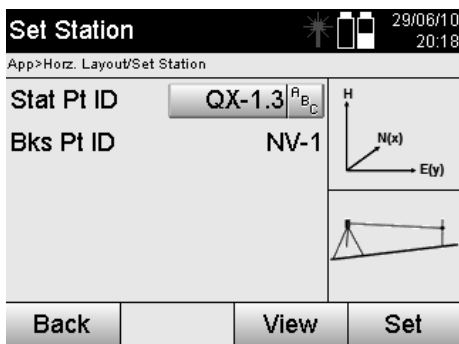

A_1 ^A _{B,C}	For entering station names.
Back	Return to orientation measurement.
View	Show station data.
Set	Setting the station.

10.2.5 Setting a station “anywhere”, with coordinates

Setting the station “anywhere” allows the position of the station to be defined by measuring the angles and distances to two reference points.

The ability to set the station “anywhere” is used when it is not possible to set it at a point on the building control line or when the line of sight to the points to be measured is obstructed.

Extra care must be taken when setting the station “anywhere”.

Additional measurements are taken in order to set the station “anywhere”. Additional measurements always present a risk of errors.

Care must also be taken to ensure that the geometry of the situation allows a usable position to be achieved.

The tool checks the basic geometric relationships in order to ensure that a usable position can be calculated and issues a warning in critical situations.

Nevertheless, the user of the tool is obliged to exercise special caution in this respect as the software is not capable of recognizing all potentially critical situations.

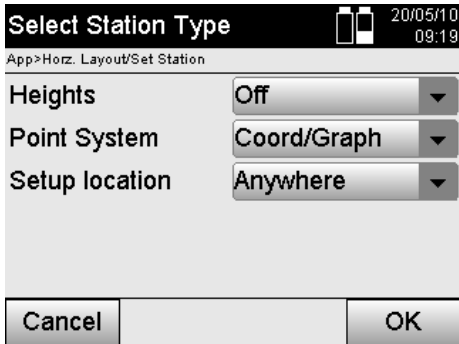

Cancel	Cancel and return to previous screen.
OK	Confirm and apply the entry.

Setting up the tool “anywhere”, with coordinates

An unobstructed and convenient location should be chosen for setting up the tool, where two coordinate points are clearly visible and where a good line of sight to the points to be measured can be ensured as far as possible. It is recommended that a mark is always first made on the ground or floor and the tool then set up over this mark. This allows the position to be checked subsequently in the event of uncertainties.

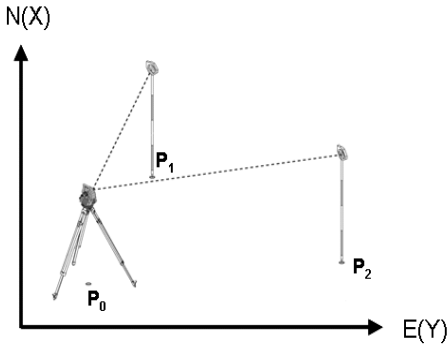



The tool is positioned at any desired point **P0** and is then used to measure, one after the other, the angle and distance to two reference points with known coordinates **P1** and **P2**. The position of the tool **P0** is then determined from the measurements taken to the two reference points.

NOTE

If the height of one or both of the reference points is known, the height of the new station will be calculated automatically. The height of the station can be redetermined and changed at any time before the station is set finally.

10.2.5.1 Measuring to the first reference point



Measure Ref Pt 1		29/06/10 15:58	
App>Horz. Layout/Measure 1st Pt			
Ref Pt 1	R1 ^R _{B,C}		
HA	14° 39' 33"		
VA	88° 56' 36"		
HD	---		
Back	Meas	Next	

B_5	Enter the name of the orientation point.
Back	Return to previous view.
Meas	Measure angle and distance.
Next	Continue to "Measure to the second reference point".

en

Corresponding coordinates or positions are searched for in the graphic data saved in the system. If no point data exists under this name the coordinates have to be entered manually.

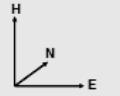
10.2.5.2 Measuring to the second reference point

Select Ref Point 2		16/06/11 17:59	
App>Horz. Layout/Station Setup			
Ref Pt 2	7		
HA	28° 21' 30"		
VA	77° 25' 05"		
HD	4.220 m		
Back	Check D	Meas	Next



Back	Return to "Measuring to the first reference point".
Meas	Measure angle and distance.
Next	Continue to "Set station".
Check D	Checking the distance between reference points

Continue by checking the distance between the station and the orientation point, as described in the applicable section.

10.2.5.3 Set station

The station is always saved in internal memory.

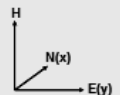
If the station name already exists in memory, the station **must** be renamed. i.e. a new name assigned to it.

Set Station		29/06/10 20:18	
App>Horz. Layout/Set Station			
Stat Pt ID	QX-1.3 ^R _{B,C}		
Bks Pt ID	NV-1		
Back	View	Set	

A_1 ^R _{B,C}	For entering station names.
Back	Return to orientation measurement.
View	Show station data.
Set	Setting the station.

10.3 Setting the height

If heights are also to be used in addition to setting the station and orientation, i.e. target heights are to be determined or laid out, the height of the center of the telescope must also be defined.

Two different methods can be used to set the height:

1. If the height of the point on the floor or ground is known, the height of the tool is then measured. The height of the center of the telescope is the sum of these two values.
2. Alternatively, an angle and distance measurement can be made to a point or mark with a known height and thus by "measuring" in this way, the height of the center of the telescope determined and transferred back to the tool.

10.3.1 Setting a station with a control line (height option "on")

If the "With heights" option has been selected, the station heights will be shown in the "Set station" screen. These can be confirmed or redefined.

Defining a new station height

Station height can be defined in two different ways:

1. Direct manual entry of the station height.
2. The station height is defined by manually entering the height of a height mark and by measuring the vertical angle and distance.

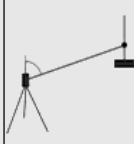
Setup Station Height		29/06/10 15:56	
App>Horz. Layout/Setup Station Height			
Stat Pt ID	OWV-1		
Stat H	---		
HI	0.000 m		
HR	0.400 m		
Back	Man H	OK	

Back	Return to previous view.
Man H	Enter station height manually or measure to a height mark.
OK	Confirm station height. Continue with setting station.

1st Direct manual entry of the station height

After the option for redefinition of the station height has been selected from the previous screen, the new station height can be entered manually here.

Enter BM Height		29/06/10 15:52	
App>Horz. Layout/Setup Station Height			
BM Height	22.000 m ¹²³		
VA	92° 31' 38"		
HI	1.650 m ¹²³		
HR	0.400 m ¹²³		
Cancel	Meas	Set	

Cancel	Cancel and return to previous screen.
Set	Confirm station height. Continue with setting station.

2nd Definition of the station height by entering a height and measuring the vertical angle and distance

The station height is transferred "back" to the station from the height mark, so to speak, by entering the reference height, tool height and reflector height in conjunction with a vertical angle and distance measurement.

When doing this it is essential that the correct tool height and reflector height are entered.

Enter BM Height  29/06/10 15:52

App>Horz. Layout/Setup Station Height

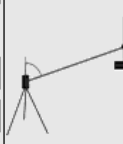
BM Height	22.000 m ¹ ₂ ₃	
VA	92° 31' 38"	
HI	1.650 m ¹ ₂ ₃	
HR	0.400 m ¹ ₂ ₃	

Cancel Meas Set

Cancel	Cancel and return to previous screen.
Meas	Measure angle and distance. Continue, showing the (re)calculated station height.

en

Showing the recalculated station height after measurement

The recalculated station height is shown after taking the angle and distance measurements and it can then be confirmed or canceled.

Set Station Height  20/05/10 10:24

App>Horz. Layout/Setup Station Height

Stat Pt ID	DL_2
Stat H	23.047 m
HI	2.000 m
HR	1.560 m

Cancel Set

Cancel	Cancel and return to previous screen.
Set	Confirm station height. Continue with setting station.

Set station

Set Station  29/06/10 15:53

App>Horz. Layout/Set Station

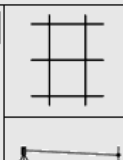
Stat Pt ID	VUM-1 ^A _B _C	
Bks Pt ID	R1	
Stat H	22.000 m	
HI	1.650 m	

Back Stat H View Set

Back	Return to orientation measurement.
Stat H	Enter station height or height mark manually or, respectively, select a previously saved height point with measurement of vertical angle and distance.
View	Show station data.
Set	Setting the station.

NOTE

When the "Heights" option is active, a height must be assigned to the station, i.e. a height value for the station must exist.

NOTE

The station is always saved in the system's internal memory. If the station name already exists in memory, the station must be renamed. i.e. a new name assigned to it.

After the station has been set, the user can continue with the actual main application previously selected.

10.3.2 Setting a station with coordinates (height option “on”)

Defining a new station height

The station height can be determined in three different ways:

en

- Direct manual entry of the station height
- The station height is determined by manually entering the height of a height mark and by measuring the vertical angle and distance.
- Definition of the station height by selecting a point with heights from data memory and measurement of the vertical angle and distance to this point

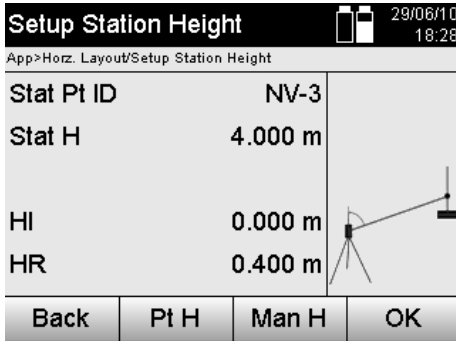

Back	Return to previous view.
	Determine new station height with saved point.
Man H	Enter station height manually or measure to a height mark.
OK	Confirm and apply the entry.

1st Direct manual entry of the station height

After the option for redefinition of the station height has been selected from the previous screen, the new station height can be entered manually here.



Cancel	Cancel and return to previous screen.
Set	Setting the station.

2nd Definition of the station height by entering a height and measuring the vertical angle and distance

The station height is transferred “back” to the station from the height mark, so to speak, by entering the reference height, tool height and reflector height in conjunction with a vertical angle and distance measurement.

When doing this it is essential that the correct tool height and reflector height are entered.

Enter BM Height  29/06/10 15:52

App>Horz. Layout/Setup Station Height

BM Height	22.000 m ¹ ₂ ₃
VA	92° 31' 38"
HI	1.650 m ¹ ₂ ₃
HR	0.400 m ¹ ₂ ₃



Cancel Meas Set

Cancel	Cancel and return to previous screen.
Meas	Measure angle and distance. Continue, showing the (re)calculated station height.

en

Showing the recalculated station height after measurement

The recalculated station height is shown after taking the angle and distance measurements and it can then be confirmed or canceled.

Set Station Height  20/05/10 10:24

App>Horz. Layout/Setup Station Height

Stat Pt ID	DL_2
Stat H	23.047 m
HI	2.000 m
HR	1.560 m

Cancel Set

Cancel	Cancel and return to previous screen.
Set	Setting the station.

3. Definition of the station height by selecting a point with heights from data memory and measurement of the vertical angle and distance

The station height is transferred "back" to the station from the height point or height mark, so to speak, by entering the height point, the tool height and reflector height in conjunction with a vertical angle and distance measurement. When doing this it is essential that the correct tool height and reflector height are entered.

Select Benchmark  29/06/10 18:30

App>Horz. Layout/Setup Station Height

BM Pt ID	QX-1.2 
BM Height	1.600 m
VA	79° 55' 10"
HI	1.750 m ¹ ₂ ₃
HR	0.400 m ¹ ₂ ₃

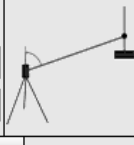

Cancel Meas

B3 	Enter height point name.
Cancel	Cancel and return to previous screen.
Meas	Measure angle and distance. Continue, showing the (re)calculated station height.

Corresponding coordinates or positions are searched for in the graphical data saved in the system. If no point data exists under this name the coordinates have to be entered manually.

Showing the recalculated station height after measurement



The recalculated station height is shown after taking the angle and distance measurements and it can then be confirmed or canceled.

Set Station Height		20/05/10 10:24
App>Horz. Layout/Setup Station Height		
Stat Pt ID	DL_2	
Stat H	23.047 m	
HI	2.000 m	
HR	1.560 m	
Cancel		Set

Cancel	Cancel and return to previous screen.
Set	Setting the station.

Set station

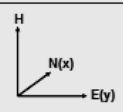
If the "With heights" option has been selected, the station heights will be shown in the "Set station" screen. These can be confirmed or redefined.

Set Station		29/06/10 16:22	
App>Horz. Layout/Set Station			
Stat Pt ID	LKS-2010		
Bks Pt ID	LKS-2011		
Stat H	2.000 m		
HI	1.750 m		
Back	Stat H	View	Set

Back	Return to orientation measurement.
Stat H	Enter station height or height mark manually or, respectively, select a previously saved height point with measurement of vertical angle and distance.
View	Show station data.
Set	Setting the station.

NOTE

When the "Heights" option is active, a height must be assigned to the station, i.e. a height value must exist. If no station height is given, an error message is displayed and the user is instructed to determine the station height.

11 Applications

11.1 Horizontal layout (Horz. layout)

11.1.1 The horizontal layout principle

The layout operation is used to transfer data from the plan to the actual object or building plot.

This plan data consists either of dimensions that relate to building control lines or positions described by coordinates. The plan data or layout positions can be entered as dimensions or distances, as coordinates or can be transferred previously from a PC.

In addition, plan data in the form of CAD drawings can be transferred to the total station and the applicable graphical points for the layout then selected from the display of the tool.

This makes working with long numbers or lots of numbers unnecessary.

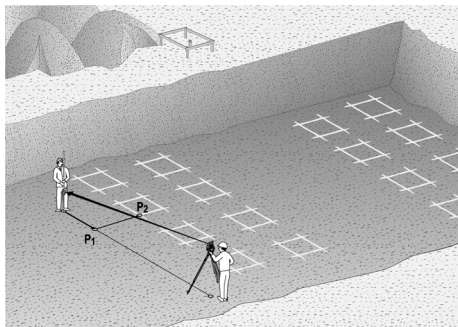

The “Horizontal Layout” application is started by way of the corresponding button in the in the application menu.

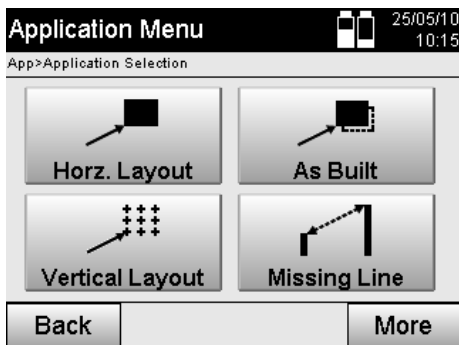

Back	Return to previous view.
Next	Continue to “Select further applications”.
Horz. Layout	Select the “Horizontal layout” application.

After starting the application, the projects or list of projects (see section 13.2) is shown for selection as well as the corresponding station selection or station setup.

The “Horizontal layout” application begins after station setup is completed.

Depending on the station selected, there are two alternative methods for determining the point to be laid out:

1. Laying out points using building control lines
2. Laying out points using coordinates and/or points based on a CAD drawing

11.1.2 Laying out with building control lines

When laying out with control lines, the layout values to be entered always refer to the building control line that has been selected as the reference axis.

Entering layout points relative to the building control line

Enter the layout point as a dimension relative to the building control line defined when the station was set or, respectively, the building control line on which the tool is set up.

The values to be entered are line and offset distances relative to the previously defined building control line.

Enter Stakeout Data	
App>Horz. Layout/Enter Stakeout Data	
Pt ID	XWQ-1
HR	0.400 m
E	6.500 m
N	12.600 m
H	2.000 m
Back	OK

Back	Return to previous view.
OK	Confirm entry and continue, showing display for aligning the tool with the point to be staked or marked out.

NOTE

Layout values on the building control line in a forwards or backwards direction from the tool station are line (longitudinal) values and those to the right or left of the building control line are offset values. Forwards and to the right are positive values, backwards and to the left are negative values.

Direction to the layout point

Using this screen, the tool is aimed at the point to be laid out by rotating the tool until the red direction indicator is at the zero position and, below this, the numerical display for angle difference shows a value as close as possible to zero. The cross hairs are then aimed at the point to be laid out and the reflector bearer can be guided into position. Alternatively, the reflector bearer can bring himself into position on the sighting line with the aid of the guide light.

Use Guide Then Measure	
App>Horz. Layout/Stake Location	
HR	0.400 m
Pt ID	XWQ-1
HA	170° 39' 03"
HD	7.824 m
Back	Meas



Back	Return to entry of layout values.
Meas	Measure distance and continue, showing layout corrections.

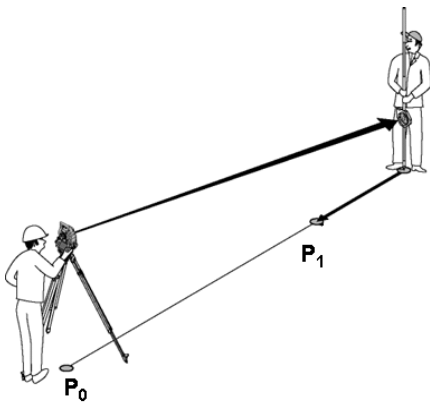

P0 is the position of the tool after setting up.

P1 is the point to be laid out and the tool is already aimed at this point.

The reflector bearer is standing close to the point (distance) calculated.

After each distance measurement the tool indicates the amount by which the reflector bearer must move, forwards or backwards, towards the point to be laid out.

Layout corrections after distance measurements

After the distance measurement has been taken, the reflector bearer is guided with the aid of the corrections **Fwd**, **Back**, **Left**, **Right**, **Up** and **Down**.

When measurements show that the reflector bearer is exactly on the sighting line, the **Right / Left** correction in the display shows a value of 0.000 m (0.00 ft).

Horz. Layout
29/06/10
21:31

App>Horz. Layout/Stake Location

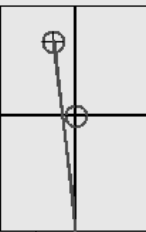
HR	0.400 m ¹²³	
Pt ID	XWQ-1	
Fwd	9.941 m	
Right	3.037 m	
Down	2.201 m	

Back
Results
Meas
Next Pt

Back	Return to entry of layout values.
Results	Show and save the result.
Meas	Measure distance and update layout corrections.
Next Pt	Enter the next point.

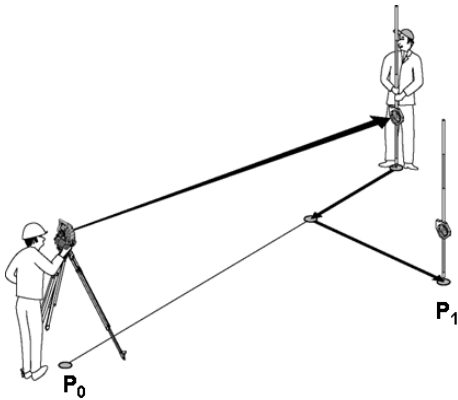

P0 is the position of the tool after setting up.

When measurements are taken to a reflector position not exactly in the direction of the new point, the corresponding **Fwd**, **Back**, **Left**, **Right** corrections to the new point **P1** are displayed.

Overview of the direction instructions to the layout point starting from the last measured target point

Fwd	The reflector bearer must move closer to the tool by the amount indicated.
Back	The reflector bearer must move further away from the tool by the amount indicated.
Left	The reflector bearer must move further to the left, as seen from the tool, by the amount indicated.
Right	The reflector bearer must move further to the right, as seen from the tool, by the amount indicated.

Up	The tip of the reflector must be moved upwards by the amount indicated.
Down	The tip of the reflector must be moved downwards by the amount indicated.

Layout results

Screen showing the layout differences in terms of line, offset and height based on the last target point measurement.

Stakeout Results
29/06/10
21:36

App>Horz. Layout/Stakeout Results

Pt ID	XWQ-1	
dE	7.400 m	
dN	8.005 m	
dH	2.405 m	

Back
Save
Next Pt

Back	Return to entry of layout values.
Save	Save the layout values and last differences.
Next Pt	Enter the next point.

NOTE

If the option to include heights was not set when the station was set up, height values and all associated information are not displayed.

Saving layout data with building control lines

Pt ID	Name of layout point.
Line (entered)	Line distance entered relative to the building control line.
Offset (entered)	Offset distance entered relative to the building control line.
Height (entered)	Height entered.
Line distance (measured)	Line distance measured relative to the building control line.
Offset (measured)	Offset distance measured relative to the building control line.
Height (measured)	Measured height.
dO	Difference in offset value based on the building control line. $dO = \text{offset (measured)} - \text{offset (entered)}$
dL	Difference in line value based on the building control line. $dL = \text{line (measured)} - \text{line (entered)}$
dH	Difference in height. $dH = \text{height (measured)} - \text{height (entered)}$

11.1.3 Laying out with coordinates

Entering the layout points

The layout values with point coordinates can be entered in three different ways:

1. Manual entry of point coordinates.
2. Selection of point coordinates from a list of points saved in memory.
3. Selection of point coordinates from a CAD drawing with points saved in memory.

Enter Stakeout Data		29/06/10 21:35
App>Horz. Layout/Enter Stakeout Data		
Pt ID	XWQ-1	
HR	0.400 m	123
E	6.500 m	
N	12.600 m	
H	2.000 m	
Back		OK

Back	Return to previous view.
OK	Confirm entry and continue, showing display for aligning the tool with the point to be staked or marked out.

en

Entering the layout points (from a CAD drawing)

The layout points are selected directly from a CAD drawing.

With this method, the point is already incorporated in the drawing as a three-dimensional or two-dimensional point and can be extracted accordingly.

Select from Map		28/06/10 14:52
App>Data Manager/Job		
Cancel	Map	List
Man	OK	

	Shows the point selected from the graphical display.
Cancel	Cancel and return to entry of layout points.
Map	Select a point from a plan.
List	Select a point from a list.
Man	Enter coordinates manually.
OK	Confirm the selected point.

NOTE

If the option to exclude heights is activated when setting up the station, height values and all associated information are not displayed. The other screens shown are the same as described in the previous section.

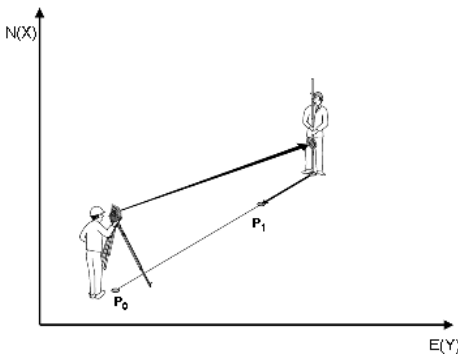

P0 is the position of the tool after setting up.

P1 is the point described by coordinates. After the tool has been lined up (aimed), the reflector bearer goes to the approximate distance calculated.

After each distance measurement the tool indicates the amount by which the reflector bearer must move towards the point to be laid out.

Layout results with coordinates

Shows the layout difference in terms of coordinates based on the last distance and angle measurements.

en

Stakeout Results
29/06/10
21:36

App>Horz. Layout/Stakeout Results

Pt ID	XWQ-1		
dE	7.400 m	+	dE
dN	8.005 m	+	dN
dH	2.405 m		

Back
Save
Next Pt

Back	Return to entry of layout values.
Save	Save the layout values and last differences.
Next Pt	Enter the next point.

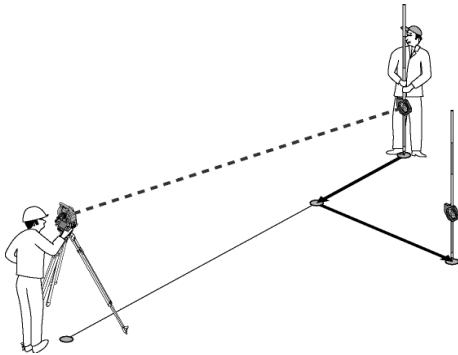

P0 is the position of the tool after setting up.

When measurements are taken to a reflector position not exactly in the direction of the new point, the corresponding Fwd, Back, Left, Right directions to the new point **P1** are displayed.

Saving data for staking out with coordinates

Pt ID	Name of layout point.
Northings (entered)	The northings entered refer to the coordinate reference system.
Height (entered)	Height entered.
Eastings (entered)	The eastings entered refer to the coordinate reference system.
Northings (measured)	Measured northings refer to the coordinate reference system.
Height (measured)	Measured height.
Eastings (measured)	Measured eastings refer to the coordinate reference system.
dN	Difference in northing based on the coordinate reference system. $dN = \text{delta north (measured)} - \text{delta north (entered)}$

dH	Difference in height. $dH = \text{height (measured)} - \text{height (entered)}$
dE	Difference in coordinate easting based on the coordinate reference system. $dE = \text{delta east (measured)} - \text{delta east (entered)}$

NOTE

The procedure for a horizontal layout with coordinates is the same as for a layout based on a building control line, with the exception that coordinates or coordinate differences are entered or shown as results instead of line or offset distances.

en

11.2 Vertical layout (Vert. layout)

11.2.1 The vertical layout principle

In a vertical layout, plan data is transferred to a vertical reference plane such as a wall or facade, etc.

This plan data is either in the form of dimensions that relate to the building control line in the vertical reference plane or positions described by coordinates in a vertical reference plane.

The plan data or layout positions in the form of dimensions or distances can be entered with coordinates or can be transferred previously from a PC.

In addition, plan data in the form of CAD drawings can be transferred to the total station and the applicable graphical points for the layout then selected from the display of the tool.

This makes working with long numbers or lots of numbers unnecessary.

Typical applications are the positioning of fastening points on facades, installation channels on walls, pipes, etc.

A special application offers the possibility of comparing a vertical surface with a theoretically absolutely flat surface in order to check for unevenness or, respectively, to produce a record of the results.

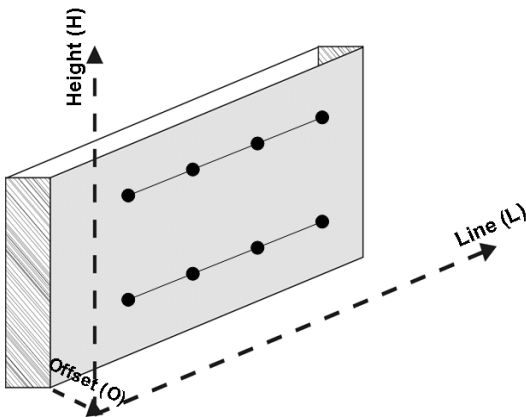

The "Vertical layout" application can be started with the corresponding button in the in the application menu.

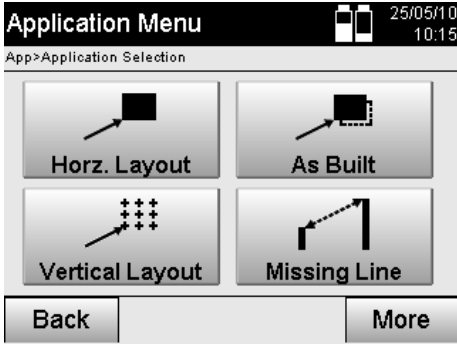

Back	Return to previous view.
Next	Continue to "Select further applications".
Vertical Layout	Select the "Vertical layout" application.

After starting the application, the projects or list of projects is shown for selection as well as the corresponding station selection or station setup.

The "Vertical layout" application begins after station setup is completed.

Depending on the station selected, there are two alternative methods for determining the point to be laid out:

1. Laying out points with building control lines, i.e. control lines in the vertical reference plane.
2. Laying out points with coordinates or points based on a CAD drawing

11.2.2 Vertical layout with building control lines

In a vertical layout with building control lines the control lines are defined by measuring to two reference points when the station is set up.

Setting up the station

The station should be set up in front of the vertical plane in a position that is as central as possible and at a distance that allows as clear a view as possible of all points.

The zero point (**1**) of the reference axis system and the direction (**2**) of the vertical reference plane are defined when the tool is set up.

Caution

The reference point (**1**) is the decisive point. The vertical and horizontal reference axes in the vertical reference plane are set on this point.

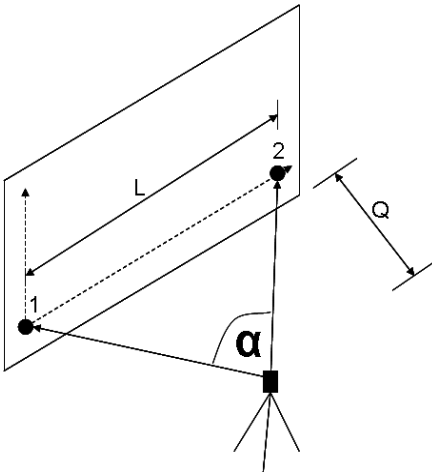

An optimum setup or, respectively, tool position has been achieved when the ratio between the horizontal reference length L and the distance Q is $L : Q = 25 : 10$ to $7 : 10$, so that the included angle lies between $\alpha = 40^\circ - 100^\circ$.

NOTE

The procedure for setting up the station is the same as for setting up the station “anywhere” with building control lines, with the difference that the first reference point is set at the zero point of the building control line system in the vertical plane and the second reference point defines the direction of the vertical plane relative to the tool system. In any case, the horizontal and vertical control lines are adopted from point (1).

Shifting a control line

In order to shift the control line system or, respectively, the “zero point” on the vertical reference plane, shift values require to be entered.

These shift values can be used to shift the zero point of the control line system to the left (-) and right (+) horizontally, up (+) and down (-) vertically, and the entire plane forwards (+) and backwards (-).

It can be necessary to shift a control line when the “zero point” cannot be sighted directly as the first reference point. An existing reference point than has to be used and then shifted onto a control line by entering the applicable shift values (distances).

L / R	0.000 m	123
U / D	0.000 m	123
F / B	0.000 m	123

Cancel OK

Cancel

Cancel and return to previous screen.

OK

Confirm entry and continue with entry of layout values.

Entering a layout position

The layout value is entered as a dimension relative to the reference axis or building control line in the vertical plane that was defined when the station was set up.

Pt ID	A	A ^R B _C
HR	0.600 m	123
Line	12.000 m	123
H	1.650 m	123
Offset	0.650 m	123

Cancel Shifts OK

Cancel

Cancel and return to the start menu.

Shifts

Enter reference plane shifts.

OK

Confirm entry and continue, showing display for aligning the tool with the point to be staked or marked out.

Direction to the layout point

Using this screen, the tool is aimed at the point to be laid out by rotating the tool until the red direction indicator shows “zero”.

The cross hairs are then aimed in the direction of the point to be laid out.

The telescope can then be moved vertically until both triangles are shown as unfilled outlines.



NOTE

If the upper triangle is solid - move the telescope downwards. If the upper triangle is solid - move the telescope downwards.

Where possible, the person holding the rod can move into position on the sighting line with the aid of the guide light.

Use Guide Then Measure
29/06/10
22:04

App>V-Layout/Stake Location

HR	0.400 m ¹ / ₂ / ₃	
Pt ID	V1	<small>dVA</small> 3° 36' 36"
HA	8° 43' 19"	
HD	3.096 m	<small>dHA</small> 23° 27' 19"

Back
Meas

- Back
Return to entry of layout values.
- Meas
Measure distance and continue, showing layout corrections.

Layout corrections

Using the corrections displayed, the target bearer or target is guided **Up, Down, Left, Right** into position.

With the aid of distance measurement, a correction **Forward** or **Back** can also be made.

The corrections shown are updated after each distance measurement until, step by step, the final position is reached.

Vert. Layout
06/07/10
03:51

App>V-Layout/Stake Location

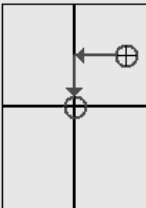
HR	0.400 m ¹ / ₂ / ₃	
Pt ID	V1	
Left	0.696 m	
Down	0.196 m	
In	0.001 m	

Back
Results
Meas
Next Pt

- Back
Return to entry of layout values.
- Results
Show and save the result.
- Meas
Measure distance and update layout corrections.
- Next Pt
Enter the next point.

Instructions displayed concerning movement of the target to which measurements are taken.

Fwd	The target must be moved further toward the reference plane.
Back	The target must be moved further away from the reference plane.
Left	The target must be moved further to the left, as seen from the tool, by the amount indicated.
Right	The target must be moved further to the right, as seen from the tool, by the amount indicated.
Up	The target must be moved further up, as seen from the tool, by the amount indicated.
Down	The target must be moved further down, as seen from the tool, by the amount indicated.

Layout results

Shows the layout difference in terms of line, height and offset based on the last distance and angle measurements.

Stakeout Results		29/06/10 22:14	
App>Horz. Layout/Stakeout Results			
Pt ID	H1		
dL	-0.128 m		
dO	-0.263 m		
dH	0.433 m		
Back	Save	Next Pt	

Back	Return to entry of layout values.
Save	Save the layout values and last differences.
Next Pt	Enter the next point.

en

Saving data for staking out with building control lines

Pt ID	Name of layout point.
Line (entered)	Line distance entered, relative to the reference axis.
Height (entered)	Height entered.
Offset (entered)	Vertical offset entered, relative to the reference plane.
Line distance (measured)	Line distance measured, relative to the reference axis.
Height (measured)	Measured height.
Offset (measured)	Offset measured relative to the reference plane.
dL	Difference in line value based on the reference axis. $dL = \text{line (measured)} - \text{line (entered)}$
dH	Difference in height. $dH = \text{height (measured)} - \text{height (entered)}$
dOffs	Difference in offset value based on the reference axis. $dO = \text{offset (measured)} - \text{offset (entered)}$

11.2.3 Vertical layout with coordinates

Coordinates can be used, for example, when coordinates are available as reference points and points in the vertical plane are also available as coordinates in the same system.

This is the case, for example, when points in the vertical plane have been measured previously using coordinates.

Entering the layout points

Three different methods can be used to enter layout values with point coordinates:

1. Manual entry of point coordinates.
2. Selection of point coordinates from a list of points saved in memory.
3. Selection of point coordinates from a CAD drawing with points saved in memory.

Enter Stakeout Data		08/07/10 02:45	
App>V-Layout/Stakeout Values			
Pt ID	QYX_1.1		
HR	1.000 m		
Line	-44.000 m		
H	-42.000 m		
Offset	1.000 m		
Cancel	Shifts	OK	

Cancel	Cancel and return to the start menu.
OK	Confirm entry and continue, showing display for aligning the tool with the point to be staked or marked out.

Entering the layout values (from a CAD drawing)

With this method the layout points are selected directly from CAD graphics.

With this method, the point is already incorporated in the drawing as a three-dimensional or two-dimensional point and can be extracted accordingly.

en

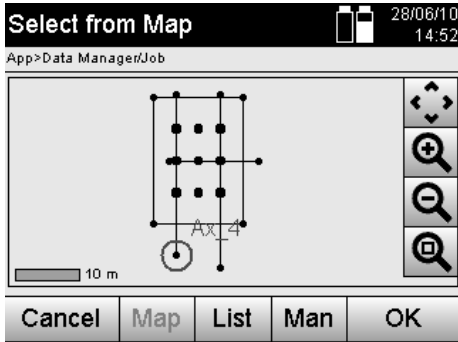

Shows the point selected from the graphical display.



Return to entry of layout values.



Select a point from a plan.



Select a point from a list.



Enter coordinates manually.



Confirm the selected point.

Layout results with coordinates

Shows the layout difference in terms of coordinates based on the last distance and angle measurements.

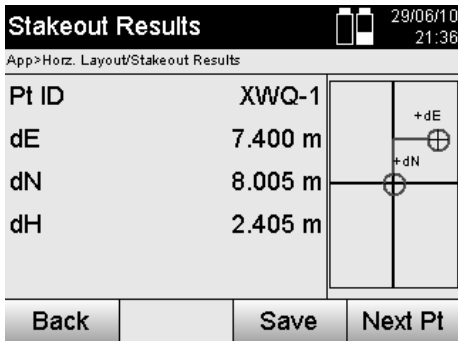

Return to entry of layout values.



Save the layout values and last differences.



Enter the next point.

Saving data for staking out with coordinates

Pt ID	Name of layout point.
Northings (entered)	The northings entered refer to the coordinate reference system.
Height (entered)	Height entered.
Eastings (entered)	The eastings entered refer to the coordinate reference system.
Northings (measured)	Measured northings refer to the coordinate reference system.
Height (measured)	Measured height.
Eastings (measured)	Measured eastings refer to the coordinate reference system.
dN	Difference in northing based on the coordinate reference system. $dN = \text{delta north (measured)} - \text{delta north (entered)}$

dH	Difference in height. $dH = \text{height (measured)} - \text{height (entered)}$
dE	Difference in coordinate easting based on the coordinate reference system. $dE = \text{delta east (measured)} - \text{delta east (entered)}$

NOTE

The vertical layout always uses three-dimensional point descriptions. In layouts with control lines and layouts with coordinates, the line, height and offset dimensions are used.

NOTE

The other screens shown are the same as described in the previous section.

11.3 As-built

11.3.1 The principle of "As-built"

In principle, as-built measurements can be regarded as a reversal of the horizontal layout application. With as-built, existing positions are compared with their positions on the plan and the deviations shown and recorded accordingly.

Depending on how the station has been set up, the plan data or, respectively, the positions to be compared, can take the form of dimensions, coordinates or points in graphics.

When plan data in the form of CAD drawings can be transferred from a PC to the total station and the applicable graphical points then selected from the display of the tool, so working with long numbers or lots of numbers is no longer necessary.

Typical applications are checking walls, columns, formwork, large openings and much more. These jobs are done by comparing positions on the plan with actual points on the object and displaying or, respectively, recording the differences.

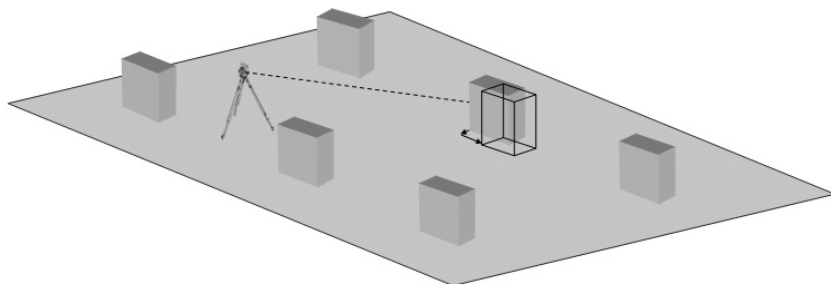

The "As-built" application is started by way of the corresponding button in the in the application menu.

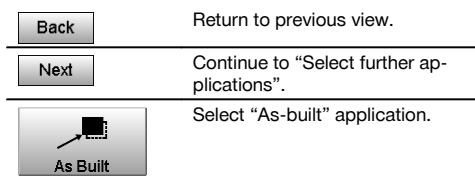
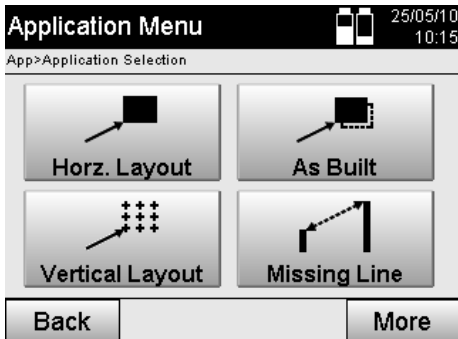

After starting the application, the projects or list of projects is shown for selection as well as the corresponding station selection or station setup.

The "As-built" application begins after station setup is completed. Depending on the station selected, there are two alternative methods for determining the as-built measurement point:

1. Measuring as-built points using building control lines
2. Measuring as-built points with coordinates and/or points based on CAD drawings.

11.3.2 As-built with building control lines

When taking as-built measurements with control lines, the as-built values to be entered always refer to the building control line that has been selected as the reference axis.

Entering an as-built position

Enter the as-built position as a dimension relative to the building control line defined when the station was set or, respectively, the building control line on which the tool is set up.

The values to be entered are line and offset distances relative to the previously defined building control line.

Enter As Built Data		29/06/10 22:59
Pt ID	H1 _{B_C}	
HR	0.400 m ¹ ₂ ₃	
Line	2.800 m ¹ ₂ ₃	
Offset	2.800 m ¹ ₂ ₃	
H	1.080 m ¹ ₂ ₃	
Back	OK	

Back

Return to previous view.

OK

Confirm entry and continue, showing display for aligning the tool with the point to be staked or marked out.

NOTE

As-built values on the building control line in a forwards or backwards direction from the tool station are line (longitudinal) values and those to the right or left of the building control line are offset values. Forwards and to the right are positive values, backwards and to the left are negative values.

Direction to the as-built point

Using this screen, the tool is aimed at the point from which the as-built measurement is to be taken by rotating the tool until the red direction indicator is at the zero position and, below this, the numerical display shows a value as close as possible to zero.

The cross hairs are then aimed in the direction of the as-built point in order to guide the reflector bearer and to identify the as-built point.

NOTE

Alternatively, for points on the ground or floor, the reflector bearer can, to a great extent, bring himself into position on the sighting line with the aid of the guide light.

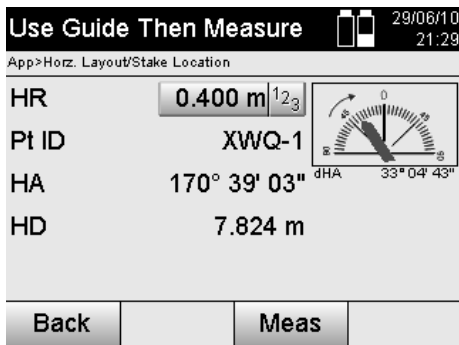

Back	Return to entry of layout values.
Meas	Measure distance and continue, showing deviations.

en

Results of as-built measurements

Shows the difference in position in terms of Line, Offset and Height based on the last distance and angle measurements.

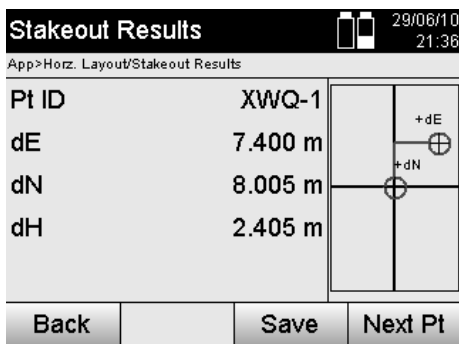

Back	Return to entry of layout values.
Save	Save the layout values and last differences.
Next Pt	Enter the next point.

NOTE

If the option to include heights was not set when the station was set up, height values and all associated information are not displayed.

Saving as-built data with control lines

Pt ID	Name of layout point.
Line (entered)	Line distance entered relative to the building control line.
Offset (entered)	Offset distance entered relative to the building control line.
Height (entered)	Height entered.
Line distance (measured)	Line distance measured relative to the building control line.
Offset (measured)	Offset distance measured relative to the building control line.
Height (measured)	Measured height.
dO	Difference in offset value based on the building control line. $dO = \text{offset (measured)} - \text{offset (entered)}$
dL	Difference in line value based on the building control line. $dL = \text{line (measured)} - \text{line (entered)}$
dH	Difference in height. $dH = \text{height (measured)} - \text{height (entered)}$

11.3.3 As-built with coordinates

Entering an as-built point

An as-built point with point coordinates can be entered in three different ways:

- Manual entry of point coordinates.
- Selection of point coordinates from a list of points saved in memory.
- Selection of point coordinates from a CAD drawing with points saved in memory.

en

Enter As Built Data	
App>As Built/Enter As Built Data	
Pt ID	KCD_1.01
HR	0.000 m
E	10.500 m
N	22.975 m
H	2.550 m
Back	OK

Back	Return to previous view.
OK	Confirm the entry and continue, showing display for aligning the tool with the point to be measured.

Entering the as-built values (from a CAD drawing)

The as-built points, in this case, are selected directly from a CAD drawing.

With this method, the point is already incorporated in the drawing as a three-dimensional or two-dimensional point and can be extracted accordingly.

Select from Map	
App>Data Manager/Job	
Cancel	Map
List	Man
OK	

	Shows the point selected from the graphical display.
Cancel	Cancel and return to entry of as-built points.
Map	Select a point from a plan.
List	Select a point from a list.
Man	Enter coordinates manually.
OK	Confirm the selected point.

NOTE

If the option to exclude heights is activated when setting up the station, height values and all associated information are not displayed.

NOTE

The other screens shown are the same as described in the previous section.

Layout results with coordinates

Shows the layout difference in terms of coordinates based on the last distance and angle measurements.

Stakeout Results		08/07/10 03:41	
App>Horz. Layout/Stakeout Results			
Pt ID	KCD_1.01		
dE	-0.363 m		
dN	2.028 m		
dH	1.509 m		
Back		Save	
		Next Pt	

Back	Return to entry of layout values.
Save	Save the layout values and last differences.
Next Pt	Enter the next point.

en

Saving data for staking out with coordinates

Pt ID	Name of layout point.
Northings (entered)	The northings entered refer to the coordinate reference system.
Height (entered)	Height entered.
Eastings (entered)	The eastings entered refer to the coordinate reference system.
Northings (measured)	Measured northings refer to the coordinate reference system.
Height (measured)	Measured height.
Eastings (measured)	Measured eastings refer to the coordinate reference system.
dN	Difference in northing based on the coordinate reference system. $dN = \text{delta north (measured)} - \text{delta north (entered)}$
dH	Difference in height. $dH = \text{height (measured)} - \text{height (entered)}$
dE	Difference in coordinate easting based on the coordinate reference system. $dE = \text{delta east (measured)} - \text{delta east (entered)}$

NOTE

The procedure for as-built with coordinates is the same as for as-built based on a building control line, with the exception that coordinates or coordinate differences are entered or shown as results instead of line or offset distances.

11.4 Missing line

11.4.1 The principle of "Missing line"

With the "Missing line" application, points anywhere within a certain space can be measured in order to determine the horizontal distance, slope distance, height difference and slope or angle between the points.

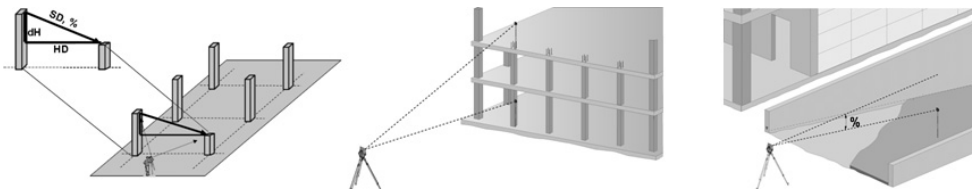

Using "Missing line" to determine inclination

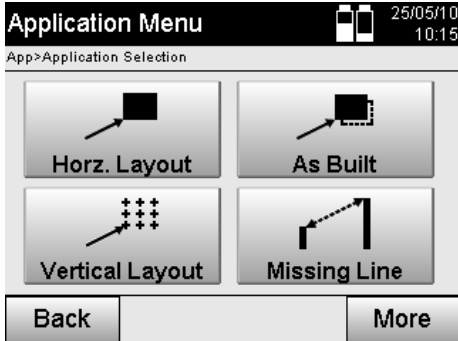

Back	Return to previous view.
Next	Continue to "Select further applications".
Missing Line	Select the "Missing line" application.

After selecting the application the list of projects is displayed.
The station does not have to be set for this application.
Two different methods can be used to determine the missing line:

1. Using the results of measurements to the first and all other measured points.
2. Using the results of measurements to two points.

1st method – relationship with a reference point

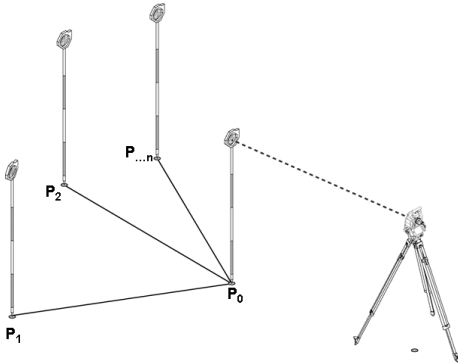

Example using points on the ground or floor

After measuring the first point, all other points measured relate to this first point.

2nd method – relationship between the first and second point

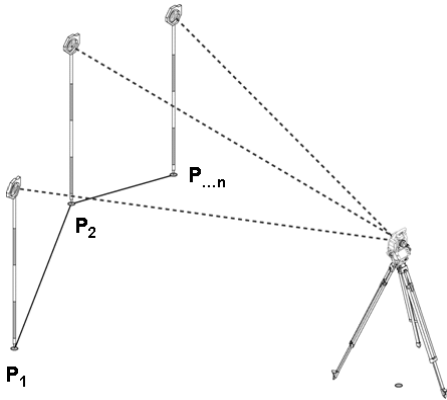

en

Example with points on the ground / floor

Measure the first two points.

After obtaining the result, choose a new line and measure the new first point and the new second point.

Measuring to the first reference point

Measure 1st Pt 30/05/10 09:06

App>Missing Line/Measure Points

HR	0.400 m ¹ ₂ ³	
HA	44° 50' 09"	
VA	88° 23' 53"	
HD	2.765 m	

Back
Meas
Next

- Back Return to project selection.
- Meas Initiate measurement to point.
- Next Continue to the next measurement.

Measuring to the second reference point

Measure 2nd Pt 30/05/10 09:08

App>Missing Line/Measure Points

HR	0.400 m ¹ ₂ ³	
HA	59° 19' 48"	
VA	77° 45' 48"	
HD	2.962 m	

Back
Meas
Results

- Back Return to previous view.
- Meas Measure angle and distance.
- Results Show the resulting missing line.

The results shown

Missing Line 30/05/10 09:11
App>Missing Line/Results

SD	0.938 m
HD	0.748 m
dH	0.565 m
Slope	75.50%

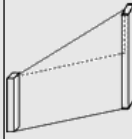

Back **New Ln** **Next Pt**

Back	Return to previous view.
Save	Save results.
New Ln	Alternative for new line. Continue to entry of a new 1st. reference point.
Next Pt	Alternative for next point: Calculate missing line relative to 1st reference point

11.5 Measure and record

11.5.1 The principle of "Measure and record"

"Measure and record" can be used to measure points with an unknown position.

Distances can be measured with the laser when the laser beam can be aimed directly at a surface.

Depending on the station setup, the positions of points are calculated with building control line dimensions or with coordinates and/or heights.

The points measured can be assigned various point designations and saved in memory.





NOTE

Each time a point is saved, the number assigned to the name of the point is raised by "1".

The point data saved in memory can be transferred to a PC for further use in a CAD or similar system or printed out for documentation and archival purposes.

The "Measure and record" application can be started by way of the corresponding button in the application menu.

Application Menu 25/05/10 11:15
App>Application Selection

 Meas & Rec	 Area
 Vert. Align.	 Remote Height

Back **More**

Back	Return to previous view.
Next	Continue to "Select further applications".
 Meas & Rec	Select the "Measure and record" application.

After starting the application, the projects or list of projects is shown for selection as well as the corresponding station selection or station setup.

The "Measure and record" application begins after station setup is completed.

Depending on the station setup selected, there are two alternative methods for determining the point system:

1. Point positions that depend on a building control line
2. Point positions that depend on a coordinate system

11.5.2 Measure and record with building control lines

The positions of the measured points relate to the building control line used as a reference.

The positions are described with a line distance on the building control line and a perpendicular offset distance.

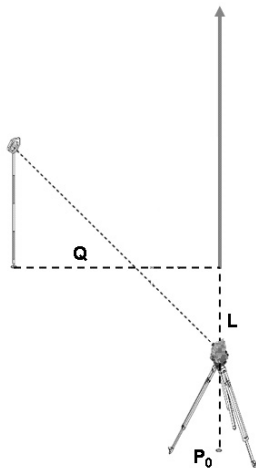

P0 is the position of the tool after setting up.

If angles and distances to target points are measured, the corresponding building control line distances L and Q are calculated and saved in memory.

Measuring points with building control lines

Measuring can begin as soon as station setup has been completed.

Measure Points 30/05/11 06:51

App>Measure & Record/Meas & Rec

Pt ID	3 ^A _{B,C}	
HA	162° 48' 37"	
VA	79° 34' 32"	
HD	3.552 m	

Back
Rec
M&R
Meas
L & O

Back	Cancel and return to options menu.
Rec	Save the horizontal distance, horizontal angle and vertical angle values shown in the display.
Meas	Measure and save the horizontal distance, horizontal angle and vertical angle.
L & O	Toggle the display to distances between control lines.
Angles	Toggle display to angle values.

Measure Points 30/05/11 08:51

App>Measure & Record/Meas & Rec

Pt ID	3 ^A _{B,C}	
L	3.552 m	
O	0.000 m	

Back
Rec
M&R
Meas
Angles

11.5.3 Measure and record with coordinates

The positions of the measured points relate to the same coordinate system used for the station setup and are described or, respectively, indicated by coordinate values E or Y, N or X and H for the heights.

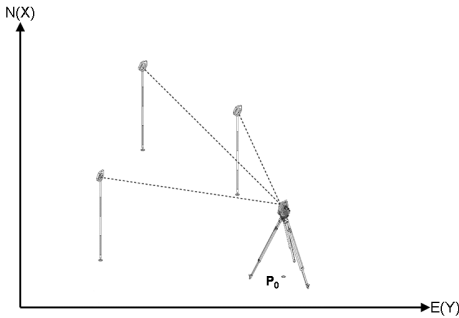

P0 is the position of the tool after setting up.

Angles and distances to the targets are measured and the corresponding coordinates calculated and saved in memory.

Measuring points with coordinates

The following screen can be toggled between displaying angles and coordinates.

Measure Points 30/05/11 06:50
 App>Measure & Record/Meas & Rec

Pt ID	2 ^{A_BC}	
HA	162° 48' 44"	
VA	79° 34' 32"	
HD	3.555 m	

Back Rec M&R Meas Coord

- Cancel and return to the start menu.

- Initiate measurement and save data. The point (designation) is increased by "1".

- Measure distance.

- Show coordinates.

- Toggle display to angle values.

- Save the horizontal distance, horizontal angle and vertical angle values shown in the display.

Measure Points 30/05/11 06:50
 App>Measure & Record/Meas & Rec

Pt ID	2 ^{A_BC}	
E	0.011 m	
N	96.445 m	

Back Rec M&R Meas Angles

NOTE

If the option to exclude heights is activated when setting up the station, height values and all associated information are not displayed.

NOTE

The horizontal distance value is fixed by measuring the distance. If the telescope is subsequently moved, only the horizontal angle and vertical angle values change.

It is sometimes difficult, or even impossible, to make an exact measurement to a certain point (e.g. to the middle of a post or tree). In this case, measure the distance to a different, laterally offset point.

1. Once you have sighted the offset point, measure the distance to it.
2. Pivot the telescope and sight the point you actually wish to measure, so that the corresponding angle can be measured.
3. Save the distance measured to the laterally offset point plus the angle to the actual point to be measured.

Saving data in memory with “Measure and record”

Pt ID	Name of measured point
E(Y), offset	Measured easting or offset distance to building control line
N(X), line	Measured northing or line distance along the building control line
Height (measured)	Measured height

11.6 Vertical alignment

11.6.1 The principle of “Vertical alignment”

Vertical alignment can be used to check that objects are vertical or to transfer vertical lines. We would like to point out the advantages of this system for setting up formwork for columns in the vertical plane or for laying out or checking points that lie vertically one above the other over several floors of a building.

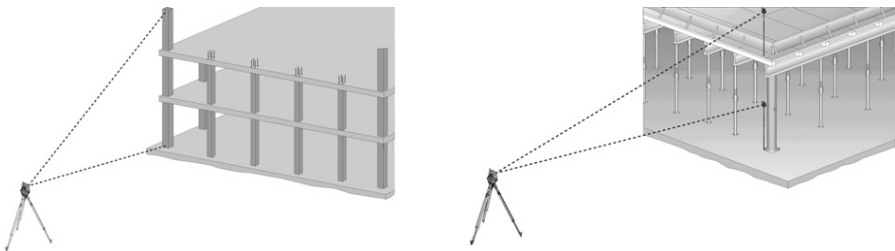

NOTE





In principle, two measured points are checked in order to determine whether they lie vertically one above the other.

NOTE

Depending on the needs of the application, the measurements can be made with or without use of a reflector rod.

Application Menu 25/05/10
11:15

App>Application Selection

 Meas & Rec	 Area
 Vert. Align.	 Remote Height

Back More

Back	Return to previous view.
Next	Continue to “Select further applications”.
 Remote Height	Select the “Vertical alignment” application.

After selecting the application the list of projects is displayed.
The station does not have to be set for this application.

Measurements to the 1st reference point

The angle and distance are measured to the 1st reference point.

The distance can be measured directly to the point or using the reflector rod, depending on ease of access to the 1st reference point.

en

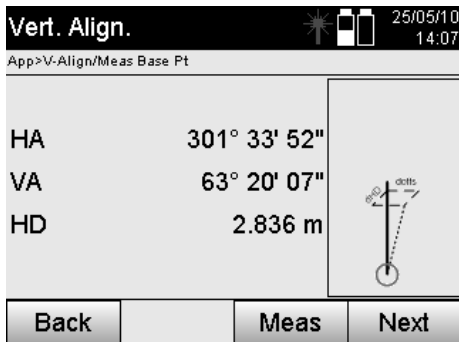

Back	Return to project selection.
Meas	Measure angle and distance to the 1st. reference point.
Next	Continue to the next measurement.

Measuring to other points

The other points are always determined by taking angle and distance measurements.

After the second and each further measurement, the correction values compared to the 1st reference point are updated in the display below.

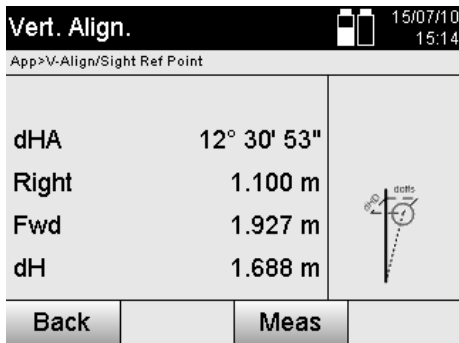

Back	Return to "Measuring to the first reference point".
Save	Save results.
Meas	Measure angle and distance and update correction values in the display.

11.7 Area measurement

11.7.1 The principle of area measurement

The tool can calculate the horizontal or vertical area enclosed by a total of up to 99 consecutively measured points. The points can be measured in a clockwise or counterclockwise sequence.

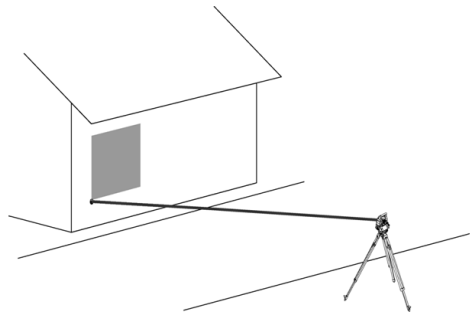
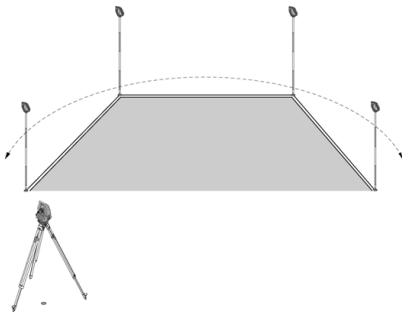

NOTE

The points must be measured in such a way that the lines between the measured points do not cross each other, otherwise an incorrect area measurement will result.

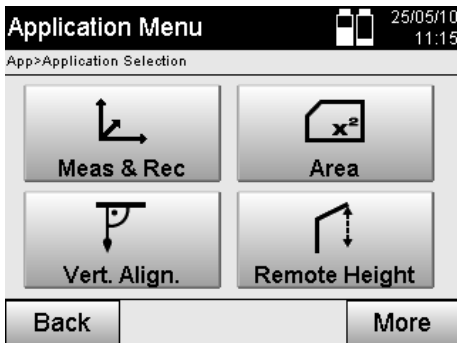

Back	Return to previous view.
Next	Continue to "Select further applications".
Area	Select the "Area measurement" application.

After starting the application, select whether the area is in the horizontal or vertical plane.

NOTE

The station does not have to be set for this application.

NOTE

The horizontal area is calculated by projecting the measured points in the horizontal plane.

NOTE

The vertical area is calculated by projecting the measured points in the vertical plane. The vertical plane is defined by the first two measured points.

Measurements for area calculation

The points should be measured in a sequence that encloses an area.

For the calculation, enclosure of the area is always completed by an imaginary line between the last measured point and the first measured point.

The points must be measured in such a way that the lines between the measured points do not cross each other, otherwise an incorrect area measurement will result.

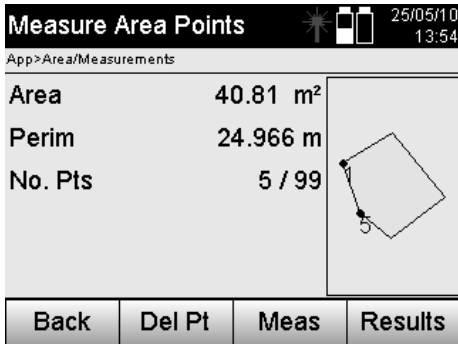

Back	Return to project selection.
Del Pt	Delete the last measured point.
Meas	Initiate measurement to point.
Results	Show the result of area measurement.

Results

The results are saved in internal memory and can be displayed on a PC or printed out using Hilti PROFIS Layout.

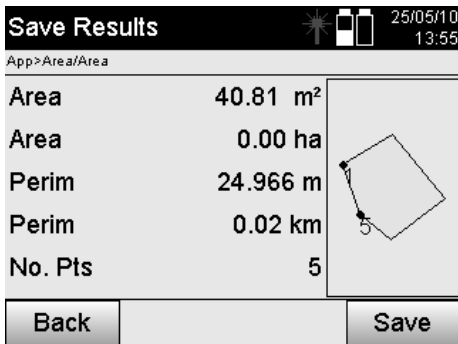

Back	Return to project selection.
Save	Save the results of area measurement.

11.8 Indirect height measurement

11.8.1 The principle of indirect height measurement

The indirect height measurement method is used to determine the height difference to inaccessible objects or points in situations where direct distance measurement is not possible.

Virtually any height or depth, e.g. heights to the extremities of a crane, the depth of an excavation or heights in many other similar situations can be determined using the indirect height measurement method.

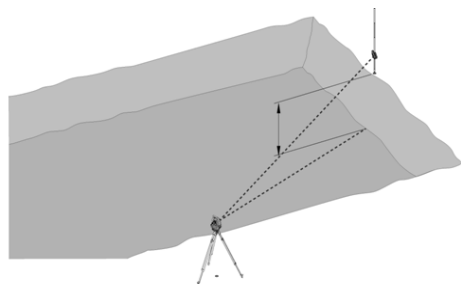
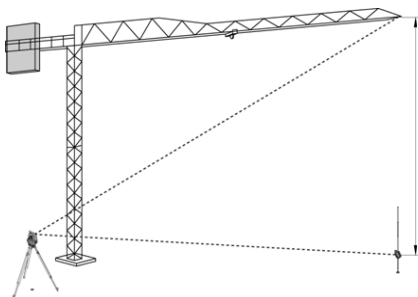

NOTE

It is essential that the reference point and the other inaccessible points all lie in the same vertical plane.

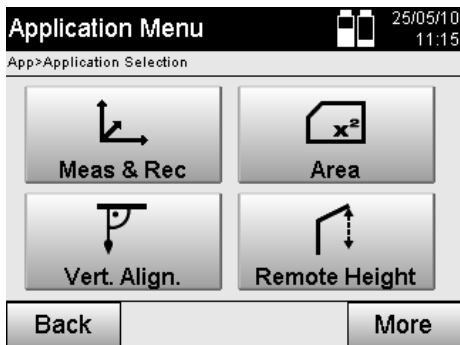

After selecting the application the list of projects is displayed. The station does not have to be set for this application.

11.8.2 Indirect height measurement

Measurements to the 1st reference point

The angle and distance to the 1st reference point are measured.

The distance can be measured directly to the point or using the reflector rod, depending on ease of access to the 1st reference point.

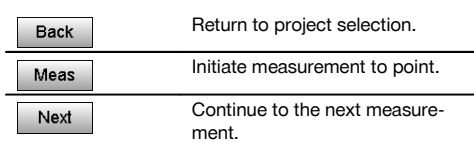
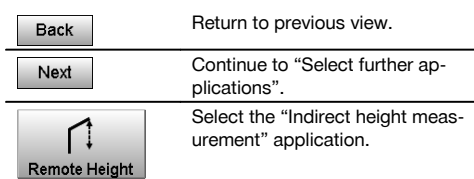
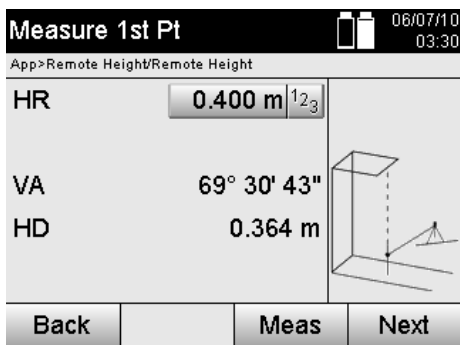

Measuring to other points

Measuring to other points is carried out simply by measuring the vertical angles. The difference in height relative to the 1st reference point is indicated continuously.

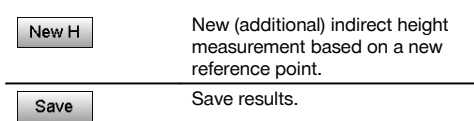
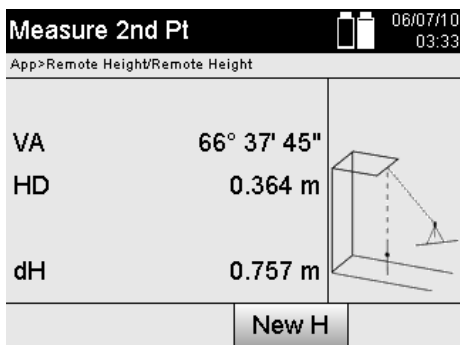

en

11.9 Determining a point in relation to an axis

11.9.1 The principle of "Point in relation to axis"

The application "Point in relation to axis", can be used to determine the position of a point (e.g. a reference point) in relation to the axis. In addition, points parallel to the axis, at right angles or at any desired angle to it, as well as points on the existing axis, can also be defined. This application is useful, above all, for example, when nails are to be placed on batter boards to indicate parallel axes on the site.

The application is performed in two steps:

1. Defining the axis.
2. Selecting or measuring the reference point.

If the station has been set up in coordinate / graphical mode, the axis and the reference point can be determined directly from the data in memory.

If the station has not already been set up, the axis must be determined by measuring its starting point and end point. The reference point is also determined by way of direct measurement.

11.9.2 Determining the axis

Measuring or selecting the first point on the axis

Measure Ref Pt 1
15/06/11
11:57

App>Point to Line

Pt ID	LinePt1 <small>R_BC</small>	
HA	343° 24' 40"	
VA	48° 30' 35"	
HD	1.700 m	
Back	Meas	Next

	Rename point on reference axis or select point form memory.
Back	Return to orientation measurement.
Meas	Initiate measurement to point.
Next	Continue to the next step.

Measuring or selecting the second point on the axis

Measure Ref Pt 2
15/06/11
11:57

App>Point to Line

Pt ID	LinePt2 <small>R_BC</small>	
HA	333° 00' 55"	
VA	53° 02' 10"	
HD	1.997 m	
Back	Meas	Next

	Rename point on reference axis or select point form memory.
Back	Go back to measurement of the first point.
Meas	Initiate measurement to point.
Next	Continue to the next step.

Shifting the axis

The axis starting point can be shifted in order to use a different reference point as the origin of the coordinate system. If the value entered is positive, the axis is moved forward. If it is negative, the axis is moved back. A positive value shifts the starting point to the right and a negative value shifts it to the left.

Enter Ref Line Shifts 15/06/11 11:58

App>Stakeout Shifts

Line **2.000 m** ¹/₂/₃

Offset **0.000 m** ¹/₂/₃



Back Rotate Meas Next

Back	Return to previous view.
	Enter axis shift manually.
Meas	Take measurement to point. The axis, distance and height values are shown. The values can be individually labeled.
Rotate	Rotate axis.
Next	Continue to the next step.

en

Rotating the axis

The axis bearing (direction) can be rotated about the starting point. If the value entered is positive, the axis is rotated clockwise. If it is negative, the axis is rotated counterclockwise.

Enter Angle Units 15/06/11 11:58

+120° 00' 00"

1	2	3	+	-
4	5	6	←	→
7	8	9	0	.

Cancel OK

Back	Return to previous view.
OK	Confirm rotation.

11.9.3 Checking points in relation to the axis

Measuring or selecting reference points

Select or Meas Check Pt 22/07/11 10:43

App>Point to Line

Pt ID **C1** 

Line **1.802 m** 

Offset **-0.018 m** 

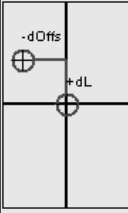

Back Save Meas New Ln

	Select point from memory.
Meas	Initiate measurement to point.
Results	Show the measured or selected points in relation to the reference axis.
Save	Save measurements.
New Ln	Determine new reference axis.

12 Data and data handling

12.1 Introduction

Hilti total stations always save data in internal memory.

The data consists of measured values, i.e. angles and distances or, depending on settings or the application, values relative to the building control line such as line and offset values or coordinates.

With the aid of PC software, data can be exchanged with other systems.

In principle, all total station data should be regarded as point data, with the exception of graphical data in which the points are incorporated.

The applicable points are available for selection and use, but not the graphics data itself, which simply provides additional information.

12.2 Point data

Point data can consist of new measured points or existing points. The total station basically measures angles and distances.

The station setup allows target point coordinates to be calculated.

Accordingly, each point that has been sighted with the cross hairs or laser pointer and the distance to it measured is calculated by the total station as a **three-dimensional point**.

These three-dimensional points are clearly identified by point designations.

A point designation, a Y-coordinate, an X-coordinate and possibly a height are given for each point.

Given points are defined by their coordinates or points with graphical elements.

12.2.1 Points in the form of measured points

Measurement data takes the form of measured points generated and saved in memory as coordinate points on the total station by the relevant application, e.g. Horz. Layout, Vert. Layout, As-built and Measure and Record.

Measured points exist only as a single instance within a station.

If the same name is used again for a measured point, the existing measured point can be overwritten or another point name assigned to it.

Measured points cannot be edited.

12.2.2 Points in the form of coordinate points

When working with the coordinate system, all positions are, as a rule, defined by a point name and coordinates - at least a point name and two horizontal coordinates X, Y or E, N are necessary to describe a point position.

The height is generally independent of the XY coordinate values.

The total station uses points in the form of coordinate points - so-called control points or fixed points and measured points with coordinates.

Fixed points are points with given coordinates, which are entered manually on the total station or transferred from USB memory or directly by way of a USB cable with the aid of Hilti PROFIS Layout.

These fixed points may also be layout points. A control point (fixed point) in a project is unique (the only one).

Control points or fixed points can be edited on the total station so long as no graphical element is attached to the point.

12.2.3 Points with graphical elements

With the aid of Hilti PROFIS Layout, graphical data can be transferred from a CAD environment, shown on the screen and selected for use.

The Hilti system allows points and graphical elements to be created in various ways using Hilti PROFIS Layout, and to subsequently transfer these to the total station for further use.

Points with attached graphical elements cannot be edited on the total station but can be edited on a PC using Hilti PROFIS Layout.

12.3 Generation of point data

12.3.1 With the total station

Each measurement taken generates a measurement data set or, respectively, a measured point. Measured points are defined either only as angle and distance values, point name with angle and distance values or as point name with coordinates.

12.3.2 With Hilti PROFIS Layout

1. Generating points from a model consisting of lines and curves shown with graphical elements

With the PC application Hilti PROFIS Layout, dimensions from the building plan can be used to generate a graphical layout which is a reproduction, so to speak, of the building plan.

With the aid of this application, the plan is reproduced in simplified graphical form on the PC, resulting in lines and curves, etc. on a graphical background.

In doing so, specific curves can be created, from which points can be generated, e.g. at regular intervals.

2. Generating points from imported CAD and CAD-compatible data

With the aid of Hilti PROFIS Layout CAD data in the DXF or AutoCAD-compatible DWG format can be transferred to a PC.

Points are then generated from the graphical data, i.e. lines, curves etc.

Hilti PROFIS Layout offers the possibility of using CAD graphics to generate point data from end points, line intersections, mid points of line segments and points on circles, etc.

The point data generated in this way is placed visibly on the original graphics elements from CAD.

The data in a CAD format can exist in various "layers". When this data is transferred to Hilti PROFIS Layout it is merged into a single layer.

NOTE

When organizing the data on the PC before it is transferred to the tool, special care must be taken to ensure that the "density" of the point data is as to be expected in the final result.

3. Importing data from tables or text files

Point data can be imported into Hilti PROFIS Layout from text or XML files and then transferred to the total station.

12.4 Data memory

12.4.1 Total station internal memory

The Hilti total station saves and organizes application data correspondingly in memory.

Point or measurement data is organized in the system according to projects and stations.

Project

A single block of control points (fixed points) or layout points belongs to a project.

A number of stations may belong to a project.

Tool station plus orientation (where relevant)

A station must always have an orientation.

Measured points with unique point designations belong to a station.

NOTE

A project can be regarded as a file, so to speak.

12.4.2 USB memory

USB memory allows data to be transferred between a PC and the total station. It is **not** used as additional main memory.

NOTE

The total station's internal memory is always used as its active main memory.

13 Total station data manager

13.1 Overview

The Data Manager provides access to the data stored in the total station's internal memory.

The Data Manager offers the following possibilities:

- Creating, deleting and copying new projects.
- Entering, editing and deleting the coordinates of control points (fixed points).
- Displaying and deleting measured points.

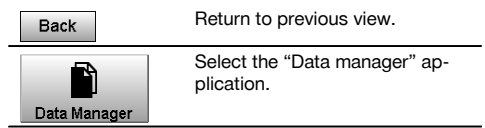
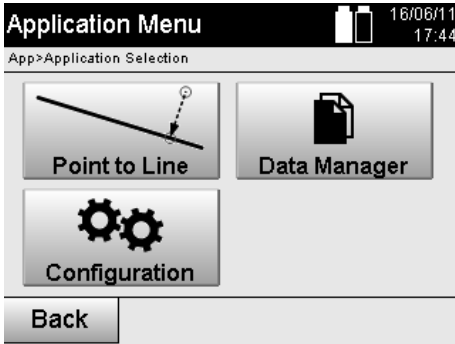

NOTE

Control points (fixed points) can be edited only when these are not attached to graphical data.

13.2 Selecting a job

After starting the Data Manager, the list of existing jobs in internal memory is shown. An existing job must be selected before the functions for points and measured points become active.

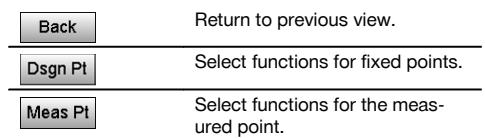
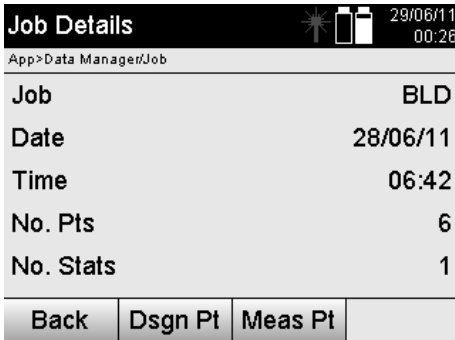
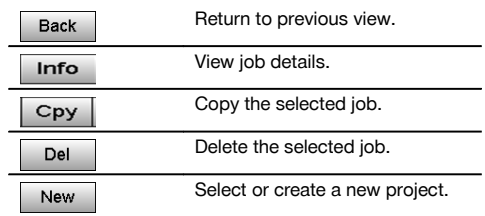

13.2.1 Fixed points (control points or layout points)

After selecting the applicable job, the option "Points" can be selected in order to enter points with coordinates or to edit or delete existing points with coordinates.

13.2.1.1 Entering points with coordinates

Manual entry of the point name and coordinates.

If the point name already exists the corresponding warning is displayed, requesting the user to change the point name.

en

Select Manually
24/07/10
10:24

App>Data Manager/Job

Pt ID	CBJ_1 ^A _B _C
E	3.000 m ¹ ₂ ₃
N	2.000 m ¹ ₂ ₃
H	1.000 m ¹ ₂ ₃

Back
Map
List
Man
OK

Back	Return to previous view.
Map	Select a point from a plan.
List	Select a point from a list.
Man	Enter a point manually.
OK	Confirm and apply the entry.

NOTE

The button for the function currently in use is shown in gray.

13.2.1.2 Selecting points from a list or graphical representation

A selection of points from a list and graphical representation is shown below.

Select from Map
06/07/10
05:47

App>Data Manager/Job

↻

+

-

📏

Back
Map
List
Man
OK

Cancel	Cancel and return to previous screen.
Map	Select a point from a plan.
List	Select a point from a list.
Man	Select a point by manual entry.
OK	Confirm and apply the entry.

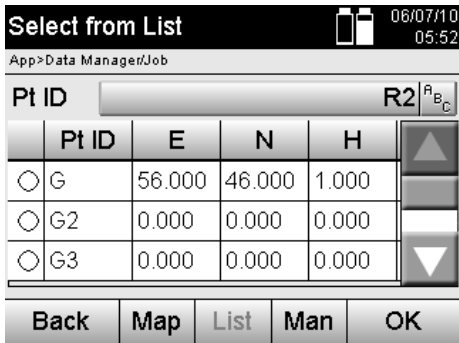

en

13.2.1.3 Editing and deleting points

After selecting and confirming the point, it can then be edited or deleted on the following screen. When editing a point, only its coordinates and height can be changed, not the name of the point. In order to change its name, the point has to be reentered in the system under a different name.

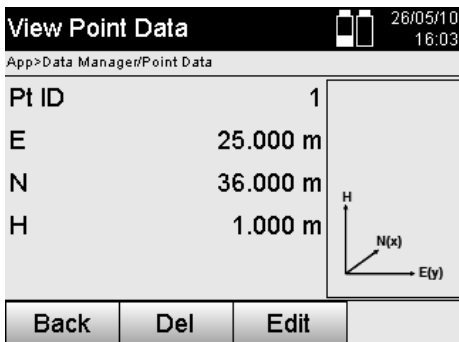

Back	Return to previous view.
Del	Delete the point shown.
Edit	Edit the point shown.

NOTE

Points with attached graphics can neither be changed nor deleted. This is possible only when working on a PC with Hilti PROFIS Layout.

13.2.2 Measured points

After selecting the applicable project, the stations and their associated measured points can be displayed. A station and all the measured points associated with it can also be deleted. In order to do this, the option "Measured points" should be selected when selecting the project.

13.2.2.1 Selecting the station

Station selection by way of manual entry of the station name, selection from a list or from a graphical display are illustrated below.

Select from List  06/07/10
05:52

App>Data Manager/Job

Pt ID ^A_B_C

	Pt ID	E	N	H	
<input type="radio"/>	G	56.000	46.000	1.000	
<input type="radio"/>	G2	0.000	0.000	0.000	
<input type="radio"/>	G3	0.000	0.000	0.000	

Back **Map** **List** **Man** **OK**

Select from Map  06/07/10
05:47

App>Data Manager/Job

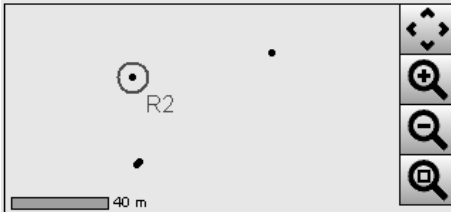

Back **Map** **List** **Man** **OK**

- | | |
|---------------|--|
| Cancel | Cancel and return to previous screen. |
| Map | Select a point from a plan. |
| Del | Delete the station and all associated measured points. |
| List | Select a point from a list. |
| OK | Confirm and apply the entry. |

en

13.2.2.2 Selecting measured points

After selecting the station, a measured point can be searched for by making a manual entry, selected from a list of measured points or selected from the graphical display.

Select from List 06/07/10 05:52
 App>Data Manager/Job

Pt ID ^A_B_C

	Pt ID	E	N	H
<input type="radio"/>	G	56.000	46.000	1.000
<input type="radio"/>	G2	0.000	0.000	0.000
<input type="radio"/>	G3	0.000	0.000	0.000

Back Map List Man OK

- Cancel and return to previous screen.

- Select a point from a plan.

- Delete point.

- Select a point from a list.

- Confirm and apply the entry.

Select from Map 06/07/10 05:47
 App>Data Manager/Job

Back Map List Man OK

13.2.2.3 Deleting and displaying measured points

After selecting the measured point, the measured values and coordinates can be displayed and the measured point then deleted.

Measured Points 06/07/10 06:20
 App>Data Manager/Measured Points

Stat ID

Pt ID

HA 21° 29' 58"

VA 78° 05' 38"

HD 4.975 m

Back Del Coord.

- Return to previous view.

- Delete point.

- Show measurement data.

- Show coordinates.

- Show distances between control lines.

13.3 Deleting a project

Before a project is deleted, the user is required to confirm this action and is given the opportunity to again view details of the project before deletion.

NOTE

When a project is deleted, all data associated with the project is lost.

13.4 Creating a new project

When entering the name of a new project, care must be taken to ensure that the name of the project does not already exist in memory.

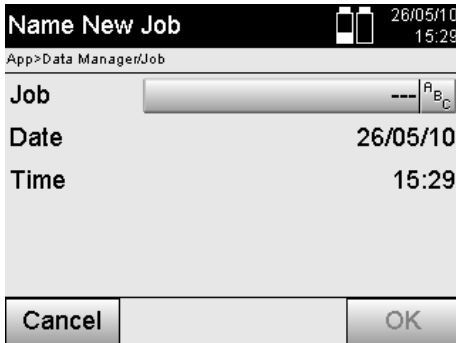

<input type="text" value="--- ABC"/>	Enter project name.
<input type="button" value="Cancel"/>	Cancel and return to project selection.
<input type="button" value="OK"/>	Confirm and apply the entry.

en

13.5 Copying a project

There are various possibilities when copying a project:

- Copying from internal memory to internal memory.
- Copying from internal memory to USB memory.
- Copying from USB memory to internal memory.

When copying, the name of the project in target memory can be changed. It is thus possible to duplicate project data by copying and renaming the project.



<input type="button" value="Int Mem"/>	Select main memory.
<input type="button" value="Int Mem"/>	Select target memory.
<input type="button" value="Cancel"/>	Cancel and return to previous screen.
<input type="button" value="OK"/>	Confirm and apply the entry.

NOTE

If the name of the project already exists in target memory, a different name must be selected or the existing project first deleted.

14 Exchanging data with a PC

14.1 Introduction

Data exchange between the total station and a PC is always via the PC application Hilti PROFIS Layout.

The data is exchanged in binary format and cannot be read without these applications.

Data can be exchanged using either the USB data cable supplied or a USB memory device (e.g. flash drive).

en

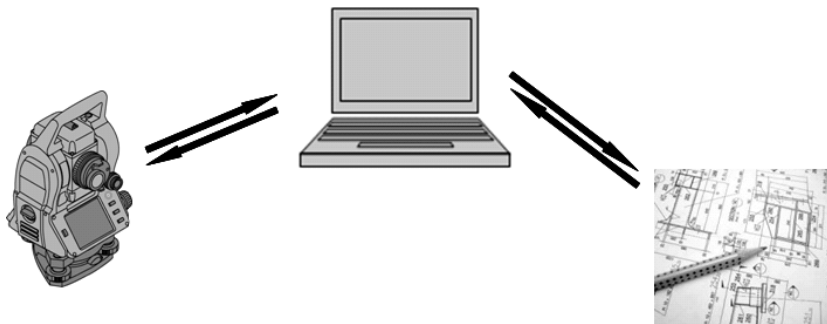

14.2 HILTI PROFIS Layout

Data is always exchanged as a complete project, i.e. all data belonging to a project is exchanged between the Hilti total station and **Hilti PROFIS Layout**.

A project may contain only control points or fixed points, with or without graphics, or a combination, i.e. control points or fixed points and measured points (measurement data) including results from the corresponding applications.

14.2.1 Data types

Point data (control points or layout points)

Control points are, at the same time, also layout points, to which graphical elements can be attached in order to facilitate identification or to describe the situation.

If these points with graphical elements are transferred from a PC to the total station, then this data will be displayed with graphics on the total station.

If control or layout points are entered manually on the total station at a later point in time, no graphical elements can be assigned or added to these on the total station.

Measurement data

Measured points or, respectively, application results can always only be transferred from the total station to **Hilti PROFIS Layout**.

The measured points transferred can take the form of point data in space-separated or comma-separated value (CSV) text format or in other formats such as DXF and AutoCAD DWG for further use on other systems.

The output of application results such as layout differences, area calculations, etc. from **Hilti PROFIS Layout** can take the form of reports in text format.

Summary

The following data can be exchanged between the total station and Hilti PROFIS Layout.

From the total station to Hilti Profis Layout:

- Measurement data: Point name, angle and distance
- Point data: Point name, coordinates and height.

From Hilti Profis Layout to the total station:

- Point data: Point name, coordinates and height.
- Graphics data: Coordinates with graphical elements.

NOTE

No provision has been made for direct data exchange between the total station and other PC systems, this can be done only by using Hilti PROFIS Layout.

14.2.2 Hilti PROFIS Layout data output (export)

Data is saved in the following applications and can be exported with the aid of Hilti PROFIS Layout in various formats:

1. Horizontal layout
2. Vertical layout
3. As-built
4. Measure and record
5. Area measurement (calculation)

Data output

Hilti PROFIS Layout reads the data saved by the total station and extracts the following data.

1. Point name, horizontal angle, vertical angle, distance, reflector height, tool height
2. Point name, E(Y) coordinate, N(X) coordinate, height
3. Application results such as differences in layouts and area measurements

Output formats

CSV format	Comma-separated values.
Text format	Gaps between data filled with spaces so that individual data items appear in columns.
DXF format	Text exchange format compatible with CAD.
DWG format	Binary data format compatible with AutoCad.

14.2.3 Hilti PROFIS Layout data input (import)

Data input

Using Hilti PROFIS Layout, the following data can be read, converted and transferred to the total station directly by cable or on a USB memory device:

1. Point names (fixed points) with coordinates and heights.
2. Polylines (lines, curves) from other systems

Input formats

CSV format	Comma-separated values.
txt format	Space-separated values.
Text format	Gaps between data filled with spaces so that individual data items appear in columns.
DXF format	CAD drawing with lines and curves as general CAD data exchange format.
DWG format	CAD drawing with lines and curves as data exchange format compatible with AutoCad.

15 Calibration and adjustment

15.1 In-the-field calibration

The tool is correctly adjusted when supplied.

The values to which the tool is set may change over time or due to temperature fluctuations, transport or aging.

The tool therefore incorporates a feature that allows the settings to be checked and, if necessary, corrected by carrying out in-the-field re-calibration.

This is done by setting up the tool securely on a tripod of good quality and targeting an easily visible, clearly discernible object within ± 3 degrees of horizontal at a distance of approx. 70 – 120 m. After this, a measurement is taken in telescope position 1 and in telescope position 2.

NOTE

Interactive instructions for this procedure are shown in the display, so it is simply a matter of following the instructions.

This application calibrates and adjusts the following three axes of the tool:

- Target axis
- VA collimation
- Dual-axis compensator (both axes)

en

15.2 In-the-field calibration

NOTE

The tool should be operated carefully in order to avoid vibration.

NOTE

The in-the-field calibration procedure requires great care and each step must be carried out very exactly. Imprecise sighting or vibration of the tool can result in incorrect calibration values, leading to subsequent measurement errors.

NOTE

In the event of uncertainty the tool should be returned to Hilti Service for checking.

1. Set up the tool in a steady, secure position on a good tripod.
2. Select "Configuration" from the application menu.

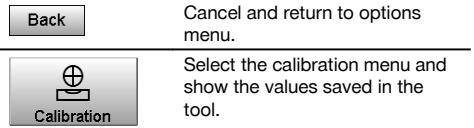
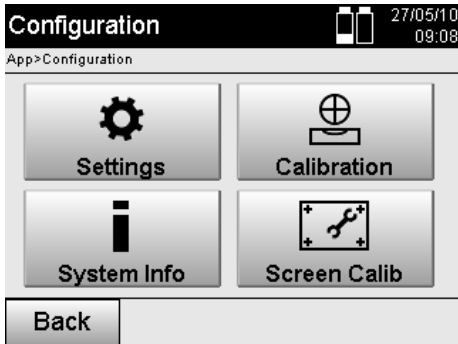

3. Then select "Calibration".

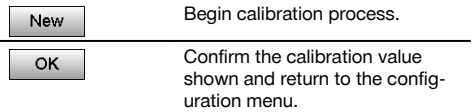
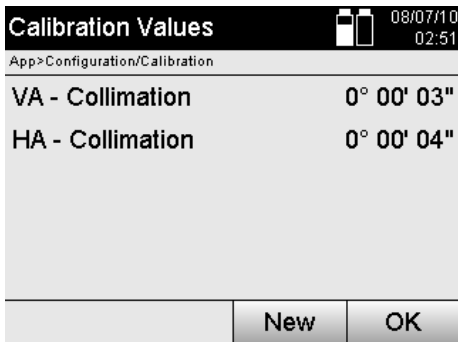

4. Start the calibration procedure or, alternatively, confirm the calibration value shown and thus cancel recalibration.

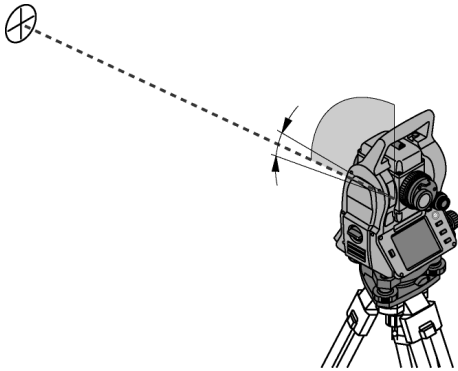

- 5. Select a clearly visible target within ± 3 degrees from horizontal at a distance of approx. 70-120 m and sight this target carefully.
NOTE Find a suitable target that can be sighted easily and accurately.
NOTE If the tool is not in the 1st telescope position a message in the display will instruct you to bring it into this position.

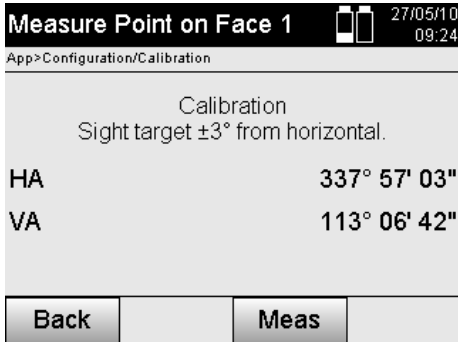

Back	Return to previous view.
Meas	Take measurement at telescope position 1.

- 6. Take the measurement in telescope position 1.
You will then be instructed to change to telescope position 2.

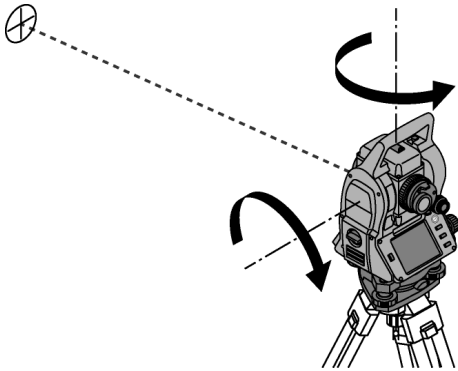

- 7. Pivot the tool carefully into the 2nd telescope position.

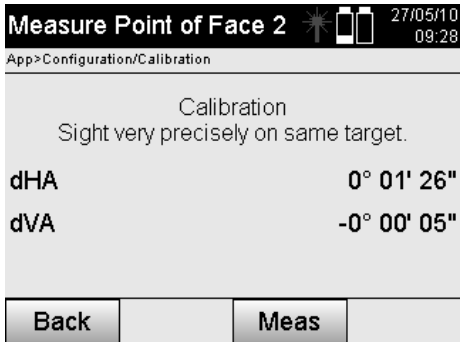

Back	Return to previous view.
Meas	Take measurement at telescope position 2.

en

- Re-sight the same target within $\pm 3^\circ$ of horizontal.
 - NOTE** This step is assisted by the display which shows the differences for the vertical circle and the horizontal circle. This serves exclusively as a sighting aid.
 - NOTE** The values should be very close to zero, i.e. with a deviation of only a few seconds, when the target is sighted with the telescope in the second position.
- Take the measurement in telescope position 2.
 - When measurements have been taken successfully in both telescope positions the new and the old settings for the vertical index and the target axis are shown.

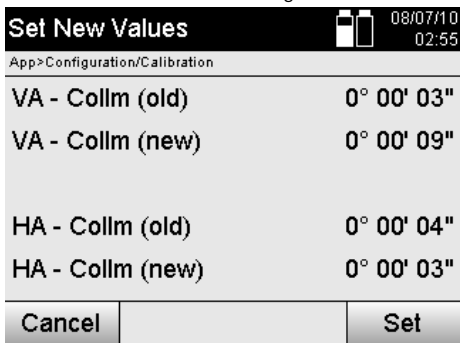

Cancel	Cancel and retain old values.
Set	Apply and save new calibration values.

- Adopt and save the new calibration values.
 - NOTE** New settings for the dual-axis compensator are also determined by way of the calibration procedure for the vertical index and target axis previously described.
 - When the new calibration values are adopted, the new settings for the compensator are also adopted.

15.3 Hilti Calibration Service

We recommend that the tool is checked by the Hilti Calibration Service at regular intervals in order to verify its reliability in accordance with standards and legal requirements. Use can be made of the Hilti Calibration Service at any time, but checking at least once a year is recommended. The Calibration Service provides confirmation that the tool is in conformance, on the day it is tested, with the specifications given in the operating instructions. The tool will be readjusted if deviations from the manufacturer's specification are found. After checking and adjustment, a calibration sticker applied to the tool and a calibration certificate provide written verification that the tool operates in accordance with the manufacturer's specification. Calibration certificates are always required by companies certified according to ISO 900x. Your local Hilti Center or representative will be pleased to provide further information.

16 Care and maintenance

NOTE

Have damaged parts replaced by Hilti Service.

16.1 Cleaning and drying

Blow any dust off the glass.

CAUTION

Do not touch the glass surfaces with your fingers.

Use only a soft, clean cloth to clean the tool. If necessary, the cloth may be moistened with a little pure alcohol or water.

CAUTION

Do not use liquids other than alcohol or water. Other liquids may damage plastic parts.

NOTE

Have damaged parts replaced by Hilti Service.

16.2 Storage

NOTE

Do not put the tool into storage when wet. Allow it to dry before putting it away.

NOTE

Always clean the tool, its transport container and accessories before putting them into storage.

NOTE

Check the accuracy of the equipment before it is used after a long period of storage or transportation.

CAUTION

Remove the batteries if the tool is to remain unused for a long period of time. Leaking batteries may damage the tool.

NOTE

Observe the specified temperature limits when storing your equipment, above all in winter and summer, especially if the equipment is stored in a motor vehicle (-30°C to +70°C (-22°F to +158°F)).

16.3 Transport

CAUTION

The batteries must be insulated or removed from the tool before the tool is shipped or sent by mail. Leaking batteries may damage the tool.

Use the Hilti shipping box or packaging of equivalent quality for transporting or shipping your equipment.

en

17 Disposal

WARNING

Improper disposal of the equipment may have serious consequences:

The burning of plastic components generates toxic fumes which may present a health hazard.

Batteries may explode if damaged or exposed to very high temperatures, causing poisoning, burns, acid burns or environmental pollution.

Careless disposal may permit unauthorized and improper use of the equipment. This may result in serious personal injury, injury to third parties and pollution of the environment.



Most of the materials from which Hilti tools or appliances are manufactured can be recycled. The materials must be correctly separated before they can be recycled. In many countries, Hilti has already made arrangements for taking back old tools or appliances for recycling. Ask Hilti Customer Service or your Hilti representative for further information.



For EC countries only

Do not dispose of electronic measuring tools or appliances together with household waste.

In observance of the European Directive on waste electrical and electronic equipment and its implementation in accordance with national law, electric tools and batteries that have reached the end of their life must be collected separately and returned to an environmentally compatible recycling facility.



Dispose of the batteries in accordance with national regulations. Please help us to protect the environment.

18 Manufacturer's warranty

Hilti warrants that the tool supplied is free of defects in material and workmanship. This warranty is valid so long as the tool is operated and handled correctly, cleaned and serviced properly and in accordance with the Hilti Operating Instructions, and the technical system is maintained. This means that only original Hilti consumables, components and spare parts may be used in the tool.

This warranty provides the free-of-charge repair or replacement of defective parts only over the entire lifespan of the tool. Parts requiring repair or replacement as a result of normal wear and tear are not covered by this warranty.

Additional claims are excluded, unless stringent national rules prohibit such exclusion. In particular, Hilti is not obligated for direct, indirect, incidental or consequential damages, losses or expenses in connection with, or by reason of, the use of, or inability to use the tool for any purpose. Implied warranties of merchantability or fitness for a particular purpose are specifically excluded.

For repair or replacement, send the tool or related parts immediately upon discovery of the defect to the address of the local Hilti marketing organization provided.

This constitutes Hilti's entire obligation with regard to warranty and supersedes all prior or contemporaneous comments and oral or written agreements concerning warranties.

19 FCC statement (applicable in US) / IC statement (applicable in Canada)

CAUTION

This equipment has been tested and found to comply with the limits for a class B digital device, pursuant to part 15 of the FCC rules. These limits are designed to provide reasonable protection against harmful interference in a residential installation. This equipment generates, uses and may radiate radio frequency energy. Accordingly, if not installed and used in accordance with the instructions, it may cause harmful interference to radio communications.

However, there is no guarantee that interference will not occur in a particular installation. If this equipment does cause harmful interference to radio or television recep-

tion, which can be determined by turning the equipment on and off, the user is encouraged to try to correct the interference by one or more of the following measures:

Re-orient or relocate the receiving antenna.

Increase the distance between the equipment and receiver.

Consult the dealer or an experienced TV/radio technician for assistance.

NOTE

Changes or modifications not expressly approved by Hilti could void the user's authority to operate the equipment.

20 EC declaration of conformity (original)

Designation:	Total station
Type:	POS 15/18
Generation:	01
Year of design:	2010

We declare, on our sole responsibility, that this product complies with the following directives and standards: 2011/65/EU, 2006/95/EC, 2004/108/EC.

**Hilti Corporation, Feldkircherstrasse 100,
FL-9494 Schaan**



Paolo Luccini
Head of BA Quality and Process Management
Business Area Electric Tools & Accessories
01/2012



Matthias Gillner
Executive Vice President
Business Area Electric Tools & Accessories
01/2012

Technical documentation filed at:

Hilti Entwicklungsgesellschaft mbH
Zulassung Elektrowerkzeuge
Hiltistrasse 6
86916 Kaufering
Deutschland

en

Index

A	
AC adapter	6
POA 81	6
Adjusting key set	6-7
Area measurement	3, 74
As-built	3, 63
with building control lines	3, 64
with coordinates	3, 66
Atmospheric influence	3, 32
B	
Battery	2, 6, 20, 22
inserting and changing	2, 20
POA 80	6
C	
Carrying handle	1
Charger	
POA 82	6
Checking functions	2, 20
Checking points	
in relation to the axis	3, 79
Configuration	2, 27
Control lines	1, 11
Control panel	2, 20
Control points	4, 83
Coordinates	1, 11
Correction	
atmospheric influences	3, 32
Correction of atmospheric influences	3, 31
D	
Data points	2, 18
Data types	4, 88
Determining the axis	3, 78
Display illumination	2, 31
Distance measurement	2, 15
Dual-axis compensator	2, 15
E	
Electronic bubble level	3, 31
Entering points	
Deleting points	84
Editing points	84
Selecting points	2, 18, 83
with coordinates	83
Entering the station position	36
Entering the target point	37, 42
Eye-piece	1

F	
Fixed point	4, 83
Focussing knob	1
Function buttons	2, 20
Function menu	
FNC	2, 30
G	
Guide light	1-2, 18, 30
H	
Height measurement	2, 17
Hilti Calibration Service	4, 92
HILTI PROFIS Layout	4, 88
Data input (import)	4, 89
Data output (export)	4, 89
Horizontal circle display	2, 25
Horizontal layout	
(Horz. Layout)	3, 50
I	
Inclination indicator	
Vertical	2, 26
Indirect height measurement	3, 76-77
In-the-field calibration	4, 89-90
J	
Job	
selecting	4, 82
L	
Laser plummet	1
Laser pointer	2, 18, 31
Status indicator	2, 22
Laying out	
with building control lines	3, 51
with coordinates	3, 54
Layout points	4, 83
M	
Measure and record	
with building control lines	3, 70
with coordinates	3, 72
Measured point	4, 84
deleting and displaying	86
Measuring principle	2, 15
Missing line	3, 67
O	
Objective lens	1

P	
POA 50	
Reflector rod (metric)	6
POA 51	
Reflector rod (imperial)	7
POA 80	
Battery	6
POA 82	
Charger	6
POAW-4	
Reflector foil	7
Point in relation to axis	3, 78
Position of the station	41
Project	
copying	4, 87
create new	3, 33
creating new	4, 87
deleting	4, 86
Project information	3, 34
Projects	3, 32
PUA 35 tripod	7
R	
Reading the circle	2, 25-26
Reflector foil	
POAW-4	7
Reflector rod	
POA 50	2, 6, 16
POA 51	7
S	
Selecting a project	3, 33
Selecting measured points	85
Selecting the station	84
Setting a station "anywhere"	3, 43, 45
Setting up the tool	
over a pipe using the laser plummet	2, 24
Showing the active project	3, 32
Switching the appliance on	2, 23
Switching the tool off	2, 23
T	
Targets	2, 16
Telescope positions	2, 13
The tool	
Setting up	2, 23
Theodolite	2, 24
Time and date	2, 29

Total station	6	Tribrach	1
Switching off	2, 23		
Touch screen		v	
Alphanumerical keyboard	2, 22	Vertical alignment	3, 73
Division	2, 21	Vertical drive	1
General operating controls	2, 22	Vertical layout	
Numerical keyboard	2, 21	Vertical layout	3, 57
Size	2, 21	with building control lines	3, 58
		with coordinates	3, 61



Hilti Corporation

LI-9494 Schaan

Tel.: +423 / 234 21 11

Fax: +423 / 234 29 65

www.hilti.com

Hilti = registered trademark of Hilti Corp., Schaan

W 3881 | 0113 | 00-Pos. 6 | 1

Printed in Germany © 2013

Right of technical and programme changes reserved S. E. & O.

433674 / A3



433674